

Catalog #9

GARY GOERS

CLASSIC CAR INTERIOR RESTORATION

Price

\$4.00 (U.S.)

NEW & REPRODUCTION PARTS

FOR CHRYSLER CORP. AUTOMOBILES 1955 AND LATER

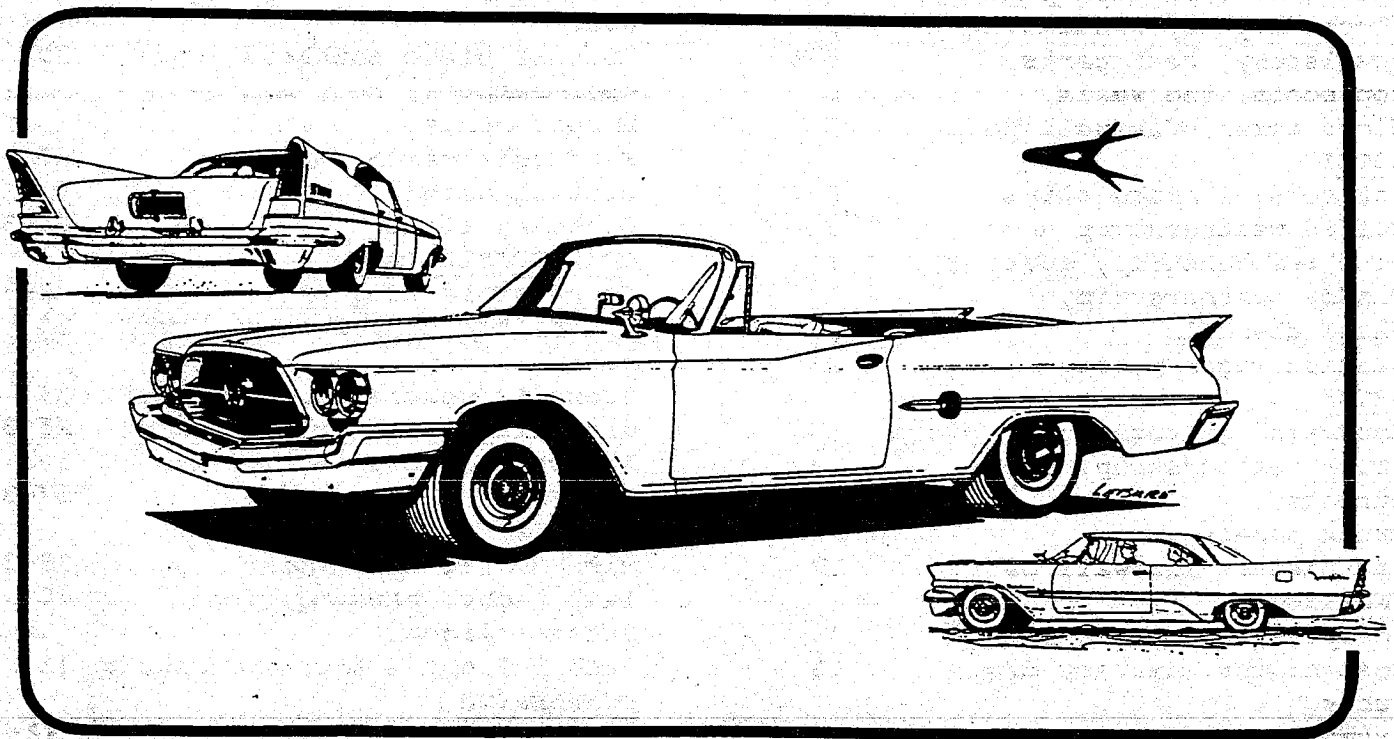

(406) 752-6249 Phone & Fax

37 Amdhal Lane Kalispell, MT 59901

World Wide Web (<http://www.garygoers.com>)

Email (goers@garygoers.com)

PLYMOUTH ♦ DODGE ♦ DE SOTO ♦ CHRYSLER ♦ IMPERIAL

I have been restoring Chrysler products since 1966 and producing restoration parts for them for over 20 years. That makes me either real old or real dumb or both. I found out early on in restoring my car that there just weren't very many parts available. The only avenue open for me to continue working on old Chryslers was to make the parts I needed. So I did and others were interested. I started printing simple sheets with my parts illustrated and the catalog evolved into this final version. My goal was to have the parts available to restore our cars and also have a well illustrated catalog which in its own way will help by serving as a guide as to what all the small rubber parts look like and where they go. I hope I have succeeded. Many thanks to Brad Leisure for his hundreds of drawings of little parts and the cover design (poor drawings are mine).

SHIPPING, PRICING, PHONE, ETC., INFORMATION INSIDE BACK COVER

Thank you for your business and support,

INDEX

Gary

INTERIOR

Gas & brake pedals	1
Dash parts, steering column seals, seat parts	2-3
Chrome screws, dash parts, floor carpets, windlacing, upholstery, seat parts,	4
Top boots, top wells,	5
Glove boxes, firewall pads	5-6
	6
	7

DOORS

Snubbers, linkage clips	8-9
Molded weatherstrip ends	9-10-11
Door weatherstrip, quarter window weatherstrip,	11
Glass channels	12
Station wagon parts	13

TRUNK

Snubbers, gaskets, body plugs	14
Trunk weatherstrip, trunk carpets,	15
Trunk panels	16
Jacksheets, firewall pads	17

UNDERHOOD

Hoodpads, hoodpad clips,	17
Hose clamps, battery drain tubes	18
Grommets	18-19-20-21
Heater drain seals	19
Wireloom straps,	20
Gaskets	20-21
nuts, bolts, heater hose outlets, power steering hoses,	21
Starter generator & Dist. tags	22

HOODSTOPS

Hoodstops	22-23
Relays, oil & temp. senders	23
Dist. leads, solenoids,	24
brushes, switches, radiator support & cowl to hood seals	

SPLASHSHIELDS

Splashshields	25-26-27
---------------	----------

BODY

Front & rear bumper shields,	27
body plugs, rear bumperguard pads,	28
License plate snubbers, gas door bumpers, body mounts, bumper bolts,	29
Headlight parts, socket & pigtail assem.	30
Moulding clips	31-32

CONVERTIBLE PARTS

Convertible only parts,	32-33
convt. top header & side rail weatherstrip,	33
Roofrail weatherstrip for H.T.	34
Windshield & backglass rubber	35-36
Windshield tools & supplies	36
Decals	37-38

GASKETS

Mirror, antenna & misc.	38-39
Tail light, parking light, license light,	40
Backup light & housing gaskets	41

SUSPENSION

Bushings, snubbers,	41-42-43
Brake parts, wheel cyl.	43
grease seals, bushings, rear spring interliners	

MISC. TOO LATE TO CLASSIFY

'57-'59 oil pressure & '57-'58 A/C oil lines	44
--	----

WEATHERSTRIPS

Door & quarter-window seals	9-10-11
Trunk weatherstrip	15
Cvt. Header & roof rail w/s	33-34
Windshield & backglass seals	35-36
Roofrail weatherstrip for H.T.	34

REPRODUCTION CHROME PARTS ON SEPARATE SHEET!!

INTERIOR

I must have your old pedals to reuse the steel ones. Please send them in with your order.

84. Gas pedal '57-'59 Chrys., Imp.



253. Gas pedal '57-'59 Windsor, '59 Dodge Exchange

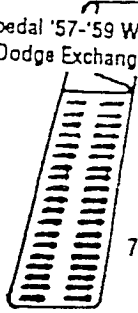

76. Brake pedal '57-'62 Dodge, Ply., '60-'62 Chrys, DeS. Also available without POWER BRAKE letters

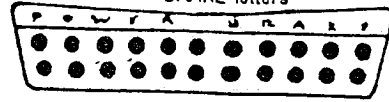

252. Brake pedal '57-'59 Windsor '59 Dodge Exchange

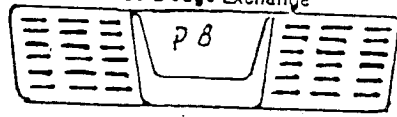

85. Brake pedal '57-'59 Chrys. POWER BRAKE

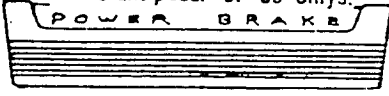

73. Gas pedal '57-'59 Ply., Dodge

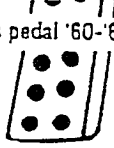

83. Gas pedal gray 9 1/2" '55, '56 Chrys., Imp. DeS., 7 1/2" '55, '56 Dodge, Ply.

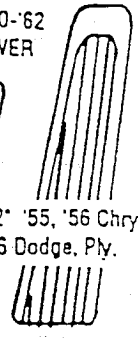

#257 Brake pedal '57-'59 Imp. [larger than Chrysler]

82. Brake Pedal Imp., Chrys., DeS., Ply., Some Dodge. '55-'56 Red or Grey; '57-'58 Black

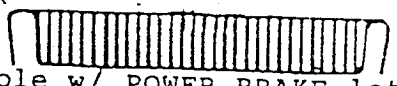

available w/ POWER BRAKE lettering

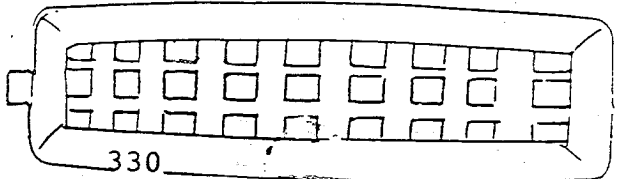

'57-'59 All makes Courtesy light lens Beautiful reproductions

284. Gas pedal '57-59 Desoto

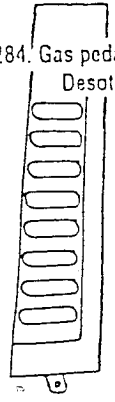

298. Brake pedal '57-59 DeSoto

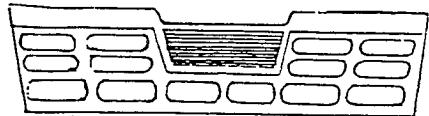

305. '60-'66 Valiant, Dart gas pedal

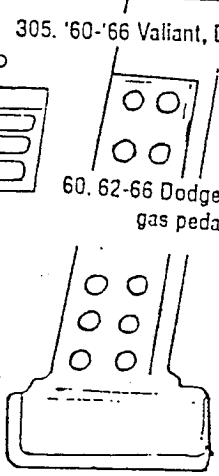

60. '62-'66 Dodge & Plym. gas pedal

326. '68 Dodge Ga

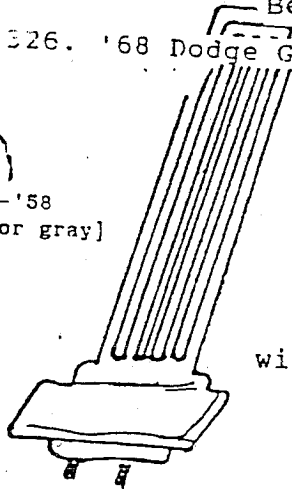

149. Brake pedal pad '60-'66 Dart, Val. auto

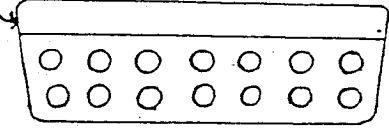

#350 A-Body brake pedal pad, automatic trans.

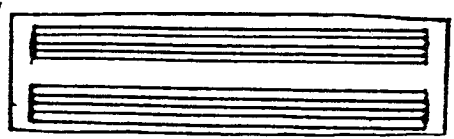

30. Vent pad '55-'58 [black, red, or gray]

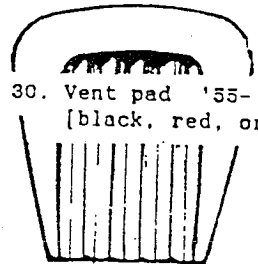

327. '61-'62 Brake & clutch Pad

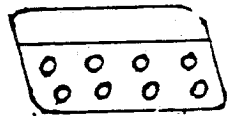

will also work on '55-'56

263. '57-'64 accel. pedal rod boot

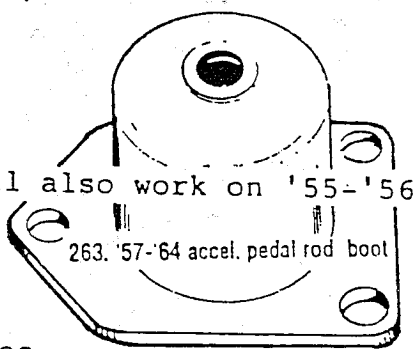

254. Manual brake and clutch pedal pad '57-'65



215. '57-'59 Imp. park pedal pad.

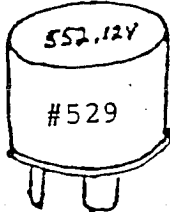

#519 '57-'58 All makes. Temp. control lever sleeve. A-black ('57); B-white ('58)

63. Parking brake pedal pad '60-'65 most cars



2 prong 12 v flasher

103. Windshield washer pad '57-'59 (black or white)

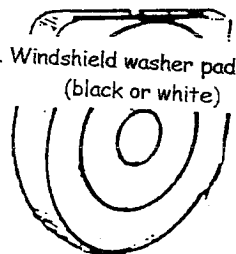

213. '60-'62 Chrys. glove box door stop arm grommet. Hard rubber

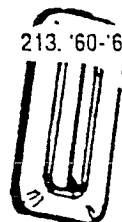

236. '57 glove box arm grommet

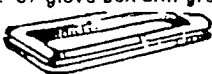

99. Firewall insulation pad retainer



89. Front seat spring mount '57

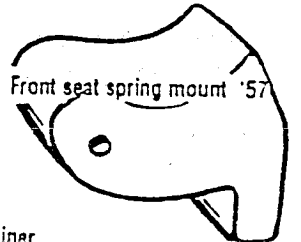

150. Spring from trans. push button unit



138. Socket head set screw 10 x 3/8 uss thread

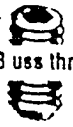

154. Pushnut for front bucket seat pins



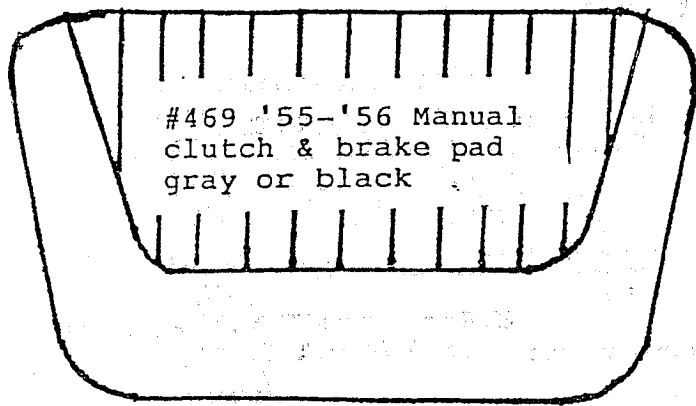

#469 '55-'56 Manual clutch & brake pad gray or black

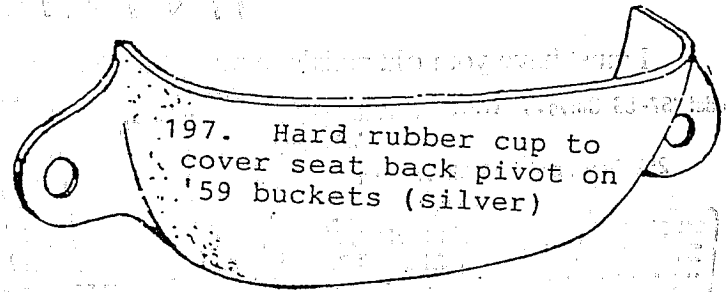

197. Hard rubber cup to cover seat back pivot on '59 buckets (silver)

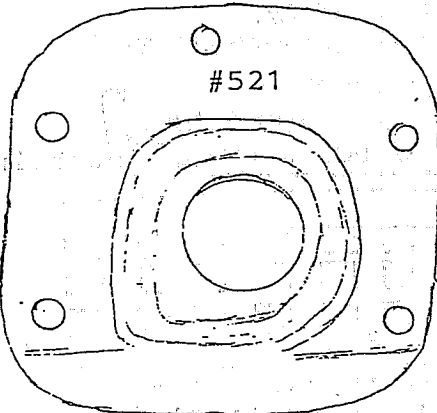

#521

#521 '59 Dodge steering column/floor seal. Must have old core.

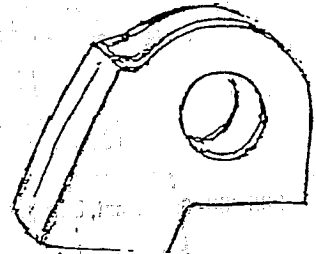

#466 '60-'66 most bucket seats front seat back hinge cover. Black hard rubber

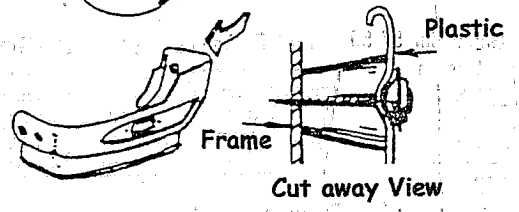
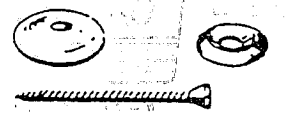
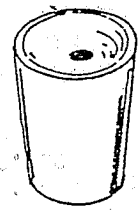

Cut away View

259. '57 front seat plastic mounting kit. custom designed to cure most mounting problems, even broken out mounting holes.

40 pc.

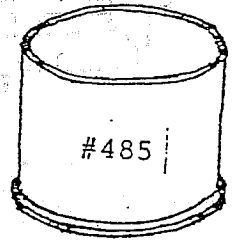

#485

108. Mast jacket seal '55, '56 C, DeSoto

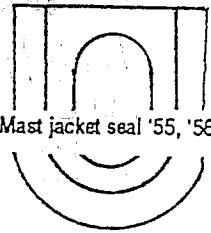

'59 steering tube end insul. with power steering

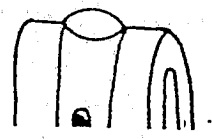

24. Steering shaft insulator

24. A. '55-'57
B. '58-'64

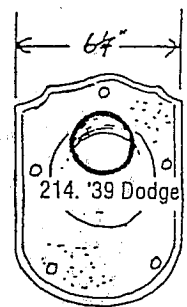

214. '39 Dodge

418 '60-'62 Exc A&B body Mast jacket seal
A Long w/base cars
B Short w/base cars
Exch. only

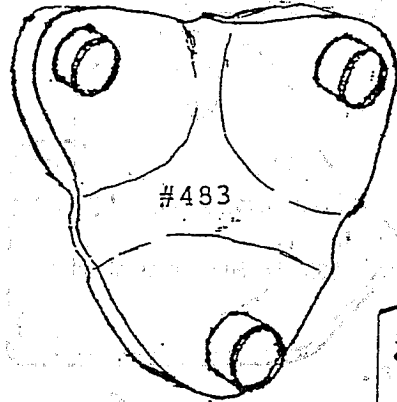

#483

'51-'52 Dodge steering box mounting pad, 2 req'd

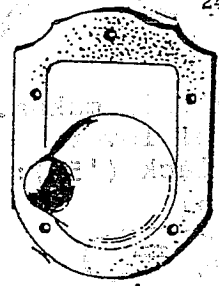

273. column seal '39 Chrys

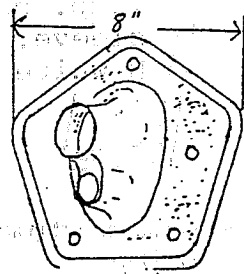

249. '40 Ply.

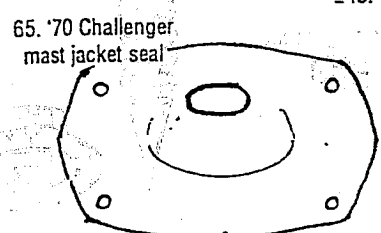

65. '70 Challenger mast jacket seal

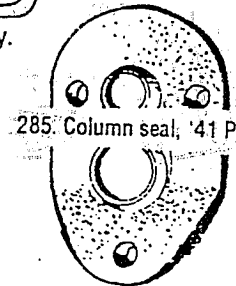

285. Column seal, '41 Ply.

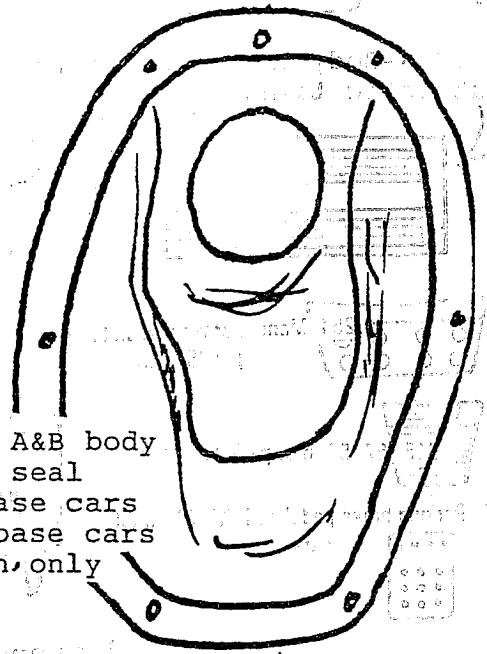

#458. '63-'66 A-body. Grommet on steering column base plate

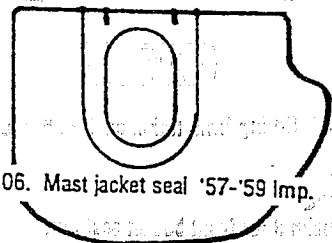

106. Mast jacket seal '57-'59 Imp.

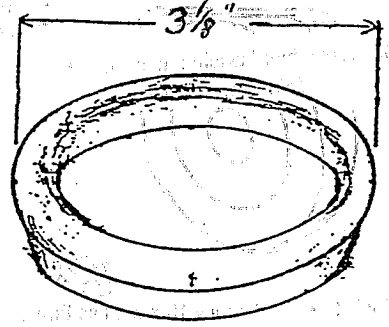

328. Column seal for '56 Ply.
not pictured-similar to #334

#449 '60-'64 Full size,
long wheel base Chrys., Des.
Secondary steering col. seal.
(see #418)

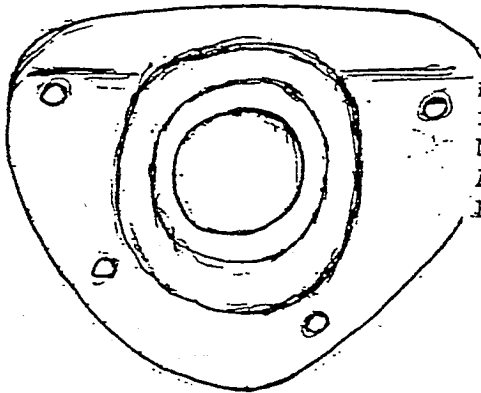

#450 Steering col. to
floor seal. Exchange.
Need your original metal
A. '57 Chrys., Des.
B. '58-'59 "some"

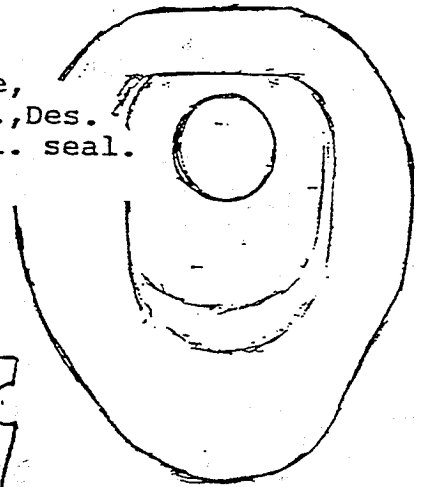

#333 '58-'59 Dodge,
Ply. steering column
seal.

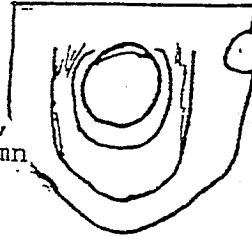

#472 A. W/ manual steering
B. W/ power steering
'57 Dodge steering col.
seal exchange

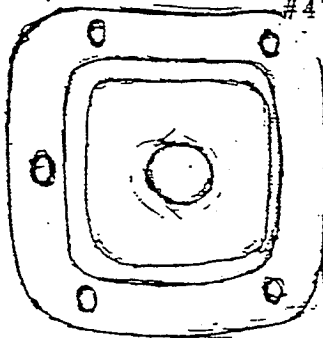

#334 '57 Dodge,
Ply. steering column
seal (also see #102AA)

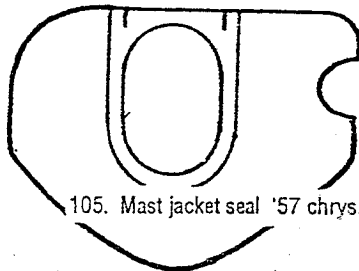
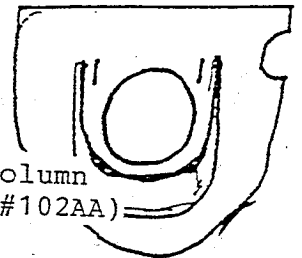

105. Mast jacket seal '57 chrys. DeS.

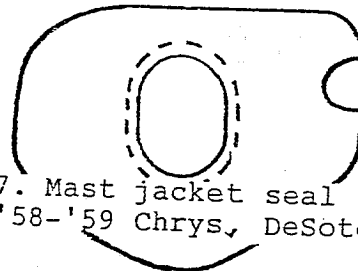

107. Mast jacket seal
'58-'59 Chrys., DeSoto



#431 Door sill
plate screw
8x1/2 truss head,
chrome



#428 STAINLESS STEEL STUDS
for convert. top boot snaps.
#8x1" Phillips head.



#430 Multi-purpose
black plastic fastener.
Replaces metal windlacing
clips.



#426 HOG RINGS

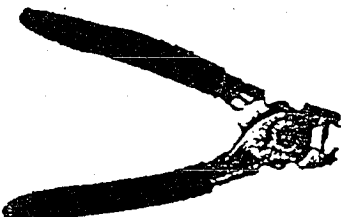

#427 HOG RING PLIERS
professional quality

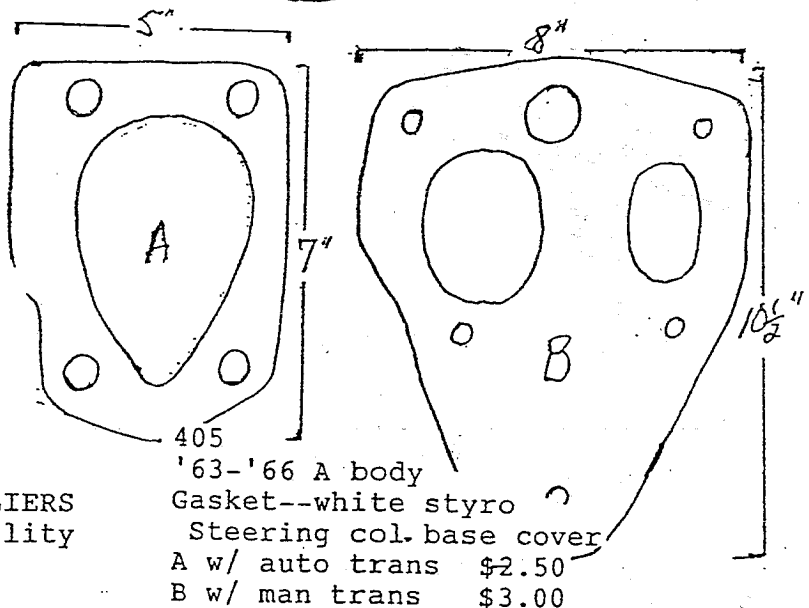

405
'63-'66 A body
Gasket--white styro
Steering col. base cover
A w/ auto trans \$2.50
B w/ man trans \$3.00

425, BURLAP Use over seat springs.

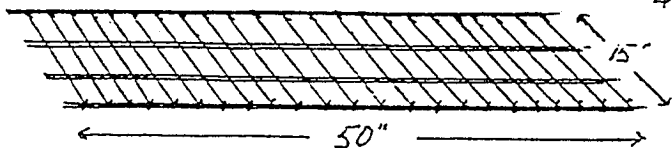

424 SEAT SPRING "LADDER" Helps distri-
bute weight evenly over springs. Replaces
old style tempered wire woven through
burlap. Can be cut for bucket seats.
Use over a burlap covering and hog ring
into place.

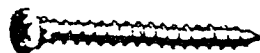

135. Chrome tapping screws

- A. #8 x 1/2" #6 head
- B. #8 x 3/4" #6 head
- C. #8 x 1-1/8" #6 head
- D. #8 x 1-1/2" #6 head
- E. #8 x 1-3/4" #8 head
- F. #8 x 2" #8 head
- G. #8 x 2-1/4" #8 head
- H. #10 x 1/2" #10 head
- I. #10 x 1" #10 head
- J. #10 x 1-1/2" #6 head
- K. #8 x 5/8" #8 head
- L. #8 x 5/8" #6 head
- M. #8 x 1" #8 head
- N. #8 x 1" #6 head



136. Lockwash & Nut

- A. 10-24
- B. 10-32
- C. 1/4 - 20
- D. 5/16 - 18



148 Binding head tapping screw '58 - '59 arm

- 176 No.4 S/S screw for stripped holes Push button plate
- 175 Courtesy Light switch screw's/s rest 14 x 2
- 147 Oval Head Phillips Machine screw
- A. 10-24 x 1/2 Glovebox hinge to dash
- B. 1/4 - 20 x 3/4 Hemi plug cover and conv. top header to side rail

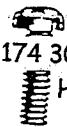

174 300 F,G,H,Console Compartment Hinge Screws A. 1/2" B. 3/4" S/S

144. Trim Panel Clip

179. Trim panel clip.

155 Special socket head screw for door window handles

DIMMER SWITCHES

D-1 \$18.65

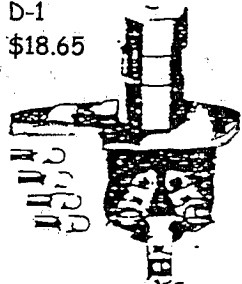

Universal - has both bullet and screw type terminals for most early applications

D-2

16.00

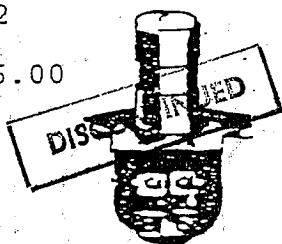

392 '60-'61 Chry Horn pad--exchange only Black--you paint to match

'57-'58

D-3 \$9.75

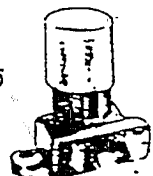

308. Push-on retainer for heater cable ends 3/16" stud size

IGNITION SWITCH

S-2

\$14.65

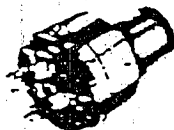

'60-'68 Cars
'61-'81 Dodge truck

'59-'82

D-4 \$18.00 (similar to D-2)

505.

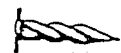

Flat head needle int. sheet metal nail. 12x1/2"

S-3

\$11.35

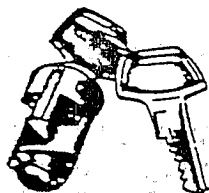

Ignition cylinder and keys for above

56. Snubbers in pushbutton unit.

'56 - '59 torqueflite

57. Powerflite



32. Ash tray snubber '59 & later



6. Glovebox snubber '55 - '65

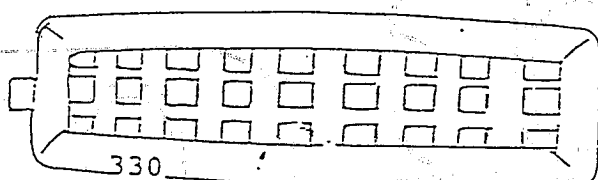

'57-'59 All makes Courtesy light lens Beautiful reproductions

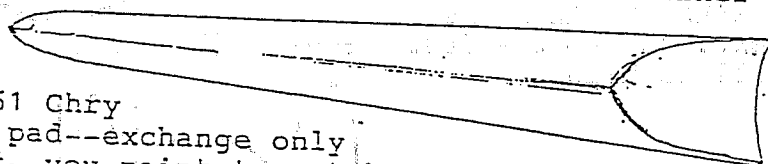

399

'65-'70 A&B body Headliner listing wire rtr.



#496

'63-'66 A-body Glovebox snubber

299. '57-'59 all H.T. & conv. front seat back stop

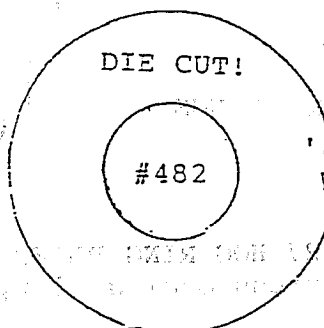

DIE CUT!

#482

'63-'66 A&B-body Window crank shield

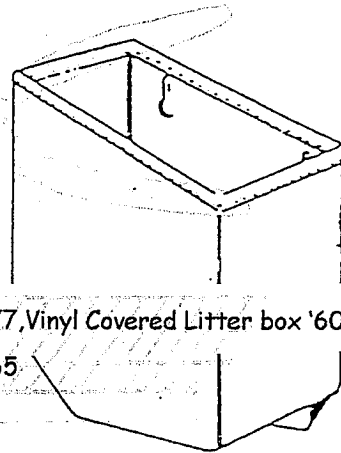

77. Vinyl Covered Litter box '60

I am a dealer for Leagendary Interiors. I can usually Save you 10 - 15%. Call or write for prices on specific items. They Make a Extensive line of Seats, Door panels, Visors & Other Interior related items for 60's and 70's cars. The colors, grains & Paterns are generally exact and are priced Extremely reasonable. The drawback is that delivery time is Generally 12 weeks and, whereas the quality of material and workmanship is equal to the price, it is not equal to factory original.

FLOOR CARPETS OTHER THAN '55 - '62 300'S

Carpets are sewn and edged as original with reproduction heel pads for each year. Send a sample for the Closest color match. The '55 - '56 Chrysler; '55 - '56 Desoto; and '60 - '66 Imperial are priced \$140. The '57 - '62 Chrysler; '57 - '59 Imperial; '57 - '59 Dodge/Plymouth; '65 - '68 C - body are priced \$125 for loop pile, and \$130 for cut pile. '60 & up are cut and sewn to replace the original molded carpets. Molded carpets are not Available for most of these and the few that are, are questionable fit and /or have the wrong heel pad. Please state make, model, number of doors, and if it has power seats or manual seats.

Panel Boards

attached to swivel seat track. priced for '59 is \$16.00.

Price for '60 - '62 is \$10.00

Vinyl Skirt

Attached to '57 front seat cushion plastic (black)
price is \$16.00 per set.

Console Inserts

Lined aluminum centers for '60 - '62 letter car
consoles. Die cut exact reproductions. polished and anodized.

Price is \$300.00 per set

Windlacing

The original cloth/ nylon type us no longer available. I carry a complete line of cloth - covered windlace which resembles the original. It is available in black, blue, navy, camel, fawn, brown, green, forest, silver, red, rust, maroon, and turquoise. with this comprehensive Color Range, I can match almost any color. Price is \$1.50 per foot. Other colors can be made with fine - knit vinyl, customed died to match your sample.

Price is \$2.25 per foot. Snap - On combo type for earlier A & B-bodies are also Available in limited colors -\$13.00/yd.

#532 '60 - '64 Chrys, cnvt.plastic
extension for bottom of rear armrest
panel. \$40.00 per set. Flocked
Black

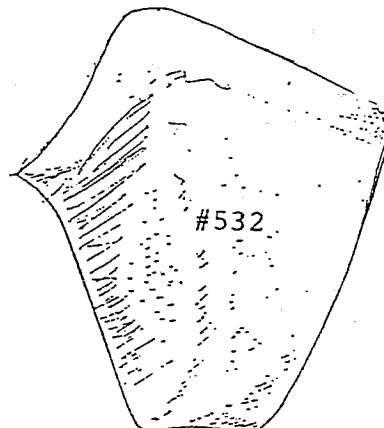

429. **SEAT FOAM FOR BUCKET SEATS** Beautiful reproductions-- cut from the highest quality "instant Rebound" foam on Specially Designed jigs to match original Contours--backed with burlap and edged with cloth where original. Use with new seat spring "ladders" and restore your seating comfort. Prevents stretching your new upholstery out of shape too. A complete set, fronts and rears, for the '60-'62 Chrysler 300 letter cars Cost \$ 360. For '60-'64 C - body, and '62-'65 A- and B- body, front bucket seats cost \$190 a pair. Incredibly, all these years and body styles used only two basic seat layout designs-- full insert or partial insert (or A combination of the two). See drawings below. Examples: the '60 - '62 letter cars all have full inserts: the '62 300 has partial inserts for the bottoms and backs; the '63 darts have full insert bottoms and partial insert Backs. Shipping for a full Front and rear set or for one or two sets of fronts (It's oversize either way) cost \$45 to the east coast, less if you closer to us.

Top boots

These boots are sewn to original patterns with snaps in place including hidden snaps where applicable. Colors vary widely and I do my best to match your sample. However, they are priced using currently available vinyl; not NOS or reproduction. These vinyls can be obtained when available at extra cost. Other boots can be made for comparable prices if you send you old one for patterns. '55-'70 Chrysler, DeSoto; '57-'59 Imperial; '57-'60 Ply., Dodge; '63-'66 Dart/Valiant; '68-'70 B-body (with correct hooks); '64-'70 C-body. All are priced \$180

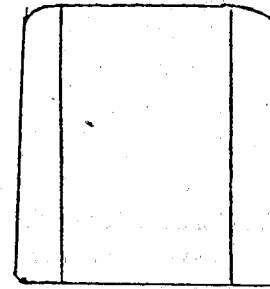

A
FULL BACK

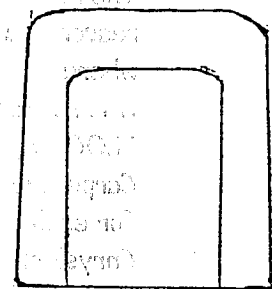

B
PARTIAL BACK

Top Wells

These are sewn to original pattern using material as close to the grain and color of your sample. NOS and reproduction vinyl can be used at extra cost. Most are available for cars listed above in top boots. Others can be made from your sample. Drains are not included. All are priced \$75

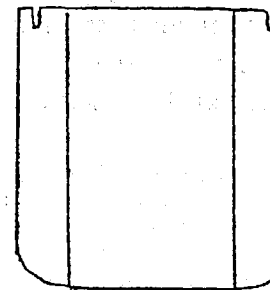

A
FULL BOTTOM

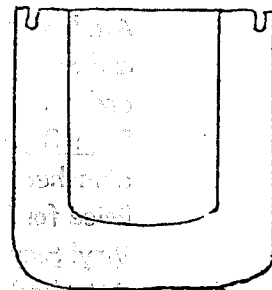

B
PARTIAL BOTTOM

Seat Upholstery Other than 300's

I am now collecting patterns for various popular chrysler products. I have found extremely close matches in color and grain for many. I now have patterns for '56-'59 Imperial; '57-'60 Chrysler NY; '57 DeSoto FF; '56-'59 Adventurer; '57-'59 Fury; '59 DeSoto FF & FD; '59 Dodge; '62 Fury; '63-'66 Dart GT; '65-'66 Valiant; '66-'69 Charger; '70 Challenger; '70 Roadrunner; '70 Chrysler 300. ('57-'59 Adventurer And fury Reproduction cloth is done, please ask for separate price Sheet). Prices are given by quote

'62 - '65 Uhpolstery --300s--

'62 Non-letter 300 leather seat upholstery kit, Top grain leather sewn to original patterns with stamps in the front backs exactly like the originals. Any Color. Fronts with center armrest \$1150 rears \$1080.

'63 300J seat upholstery kit. Top Grain leather sewn to original Patterns. Custome Finished to Match the original Color. Fronts \$1300 Rears \$1100

'64 300K seat upholstery Kit. Top grain Leather sewn to the Original patterns. Fronts \$1185 Rears \$1080 Pearl white add \$70.

'65 300L seat upholstery kit. Top grain leather sewn to original patterns. Black fronts \$1165 Rears \$1100 Other colors add \$75. Console Carpet \$60. Floor Carpet (must reuse Heel pads) \$120

'55 - '62 LETTER SERIES 300 Ask For Separate Complete Price sheet.

ATTENTION

63 Dart GT lovers.
Door and rear Panel
embossed winyl skins
Beautiful Reproductions.
Exactly like Originals
An easy Glue job and your
done! State color.

Set of four/ \$350.

300L lovers check this!

Complete set of embossed
door and rear panel vinyl
Skins \$400.00
State color(s) Note: these
Are made as they are ordered
and could take two
months for delivery.

CARPET PAD \$6.70/yard

High Quality easy-to-
work-with synthetic jute
 $\frac{1}{2}$ " thick by 36" wide

Glove boxes

These custom cut reproductions feature scored folds and stapled construction like the originals. The Greatest care was taken to collect Original boxes to make accurate patterns for the Best possible reproductions.

IMPERIAL

GB1*	'55-'56	\$40
GB2*	'57-'59	\$45
GB3*	'60-'63	\$45
GB4*	'64-'66	\$40
GB41	'67-'68	\$38
GB10	'70-'71	\$43

CHRYSLER

GB51	'35 Airstream	\$38
GB30	'37 Airflow	\$40
GB50*	'47	\$38
GB1*	'55-'56	\$40
GB5	'57-'58	\$35
GB6	'59	\$43
GB7A	'60-'61 w/o AC	\$38
GB7B	'60-'62 WAC	\$41
GB8A	'62- w/o AC	\$39
GB8B	'62- WAC	\$42
GB9A	'63-'64 w/o AC	\$38
GB9B	'63-'64 WAC	\$41
GB42	'67-'68	\$45
Above replaces molded original		
GB10	'70	\$45

Dodge

GB39*	'50-'51	\$38
GB47	'54	\$38
GB12	'55-'56	\$38
GB13	'57-'58	\$40
GB34	'57-'58 Truck	\$35
GB14	'59	\$40
GB15A	'60-'61 w/o AC	\$39
GB15B	'60-'61 W AC	\$38
GB16*	'61-'62 Lancer	\$40
GB33	'63-'64 Dart	\$35
GB17	'64 B-body	\$35
GB18	'65 B-body	\$35
GB19	'66 Polara	\$38
GB52	'67 Polara	\$41
GB20	'66-'67 B-body	\$37
GB21	'67-'72 A-body	\$38
GB22	'68- B-body	\$38
GB23	'69- B-body	\$36
GB24	'69-'72 Monaco	\$38
GB25	'70-'74 E-body	\$38
GB32	'70 B-body	\$38

* These are Flocked Gray as Original.

DeSoto

GB45*	'48	\$42
GB40*	'50	\$40
GB36*	'55-'56	\$40
GB 11*	'57-'58	\$42
GB 6	'59	\$43
GB15A	'60-'61w/oAC	\$39
GB15B	'60-'61W AC	\$42

Plymouth

GB35*	'39	\$42
GB48	'46-'48	\$38
GB44	'49	\$38
GB46	'52	\$38
GB43	'55-'56	\$37
GB26	'57-'58	\$37
GB27	'59	\$37
GB38	'60	\$40
GB28	'60-'62 Valiant	\$40
GB29	'61	\$38
GB33	'63-'66 Valiant	\$35
GB49	'65 Fury	\$38
GB31	'67 Fury	\$40
GB21	'67-'72 Valiant	\$37
GB21	'67-'69 B'cuda	\$37
GB22	'68 B-body	\$38
GB37	'68 Fury	\$38
GB23	'69 B-body	\$38
GB70	'70 B-body	\$38

FIREWALL PADS

FP1	'55-'56 Chrys. DeS. Imp.	\$63
FP2	'57-'58 Chrys. DeS. Dodge Ply.	\$63
FP3	'57-'59 Imperial	\$63
FP4	'59 Chrys., DeS., Dodge Ply.	\$63
FP5	'60 Chrys., Desoto	\$63
FP6	'60-'63 Imperial	\$63
FP7	'61 Chrys., Desoto	\$63
FP8	'62-'64 Chrysler	\$46
FP10A	'63 A - Body man	\$46
FP10B	'63 A - body Auto	\$46
FP11A	'64-'66 A - body man	\$46
FP11B	'64-'66 A - body Auto	\$46
('64-'66 state 6 cyl or V8)		

These pads are cut out of heavy duty waterproof panel board with a rubber skirt sewn on where original. Padded with 1" fiberglass and ready to install. See #99 retainers in interior section.

Your car's glove box or firewall pad not listed? I can work up patterns and make one for comparable prices if you'll send me your old one.

DOORS

SIDE GLASS & RELATED PARTS

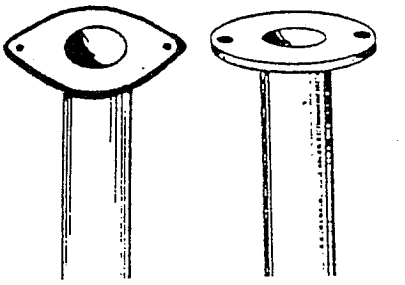

79 Pow window wire loom tube.
A. '64 B '60 - '63

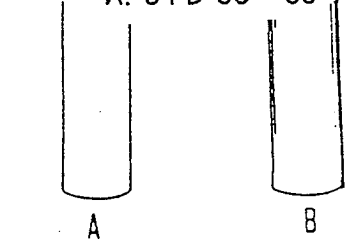

A B

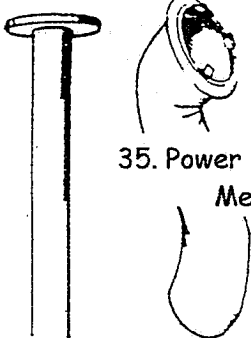

109. Power window wire loom tube '57-'62 Imperial

36. Grommet in door hole for 35

35. Power window wire tube '57 - '59
Metal not included



118. Grommet in door For # 79 A. & B.

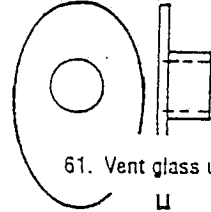
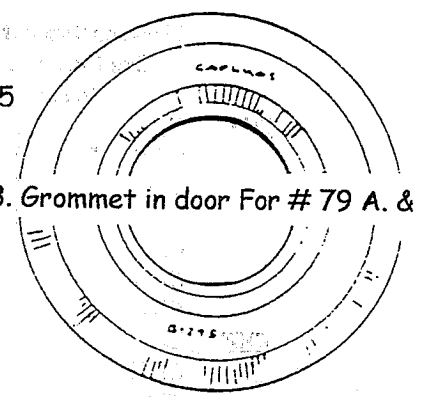

61. Vent glass upper pivot gaskets '57-'64

104. Side glass bottom stop '57-'64

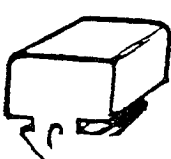

19. Door snubber '60-'64

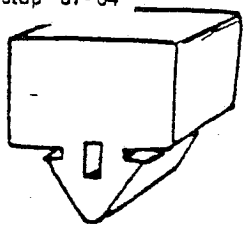

114. Door snubber '65-'68 large cars and later '60-'68 small cars & later

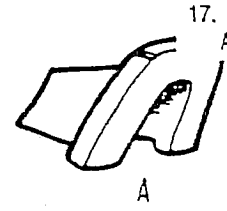

17. Division bar upper cushion
A. '57-'59 B. '60-'64

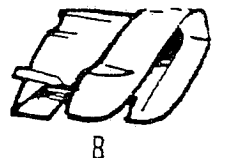

A

B



18. Door snubber '60-'64

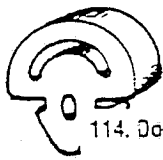

157 Division bar upper cushion '63 - '66
A. body

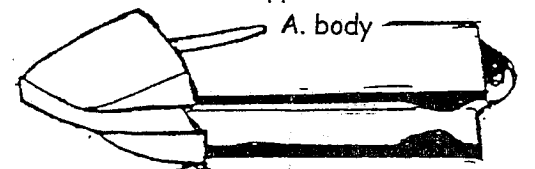

37. Lower door hinge seal '57-'59

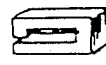

277. Grommet in door & door post for '61 with power door locks.

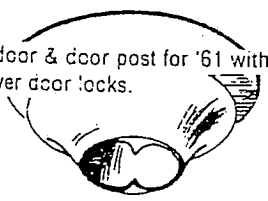

246. '60 & up door lock clip



248. '60 & up door handle ball clip

158. Division bar upper cushion '57 - '69 A - body (can mold w/metal insert if you send old ones)

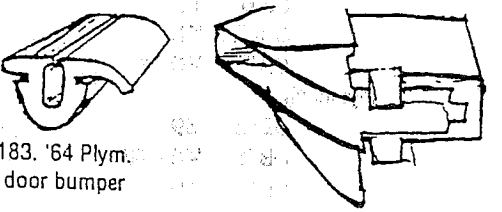

409 '56 Dod, Ply. P/W wire loom tube
387 Clip--wire rtr.

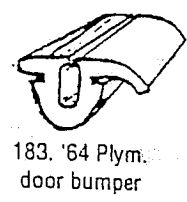
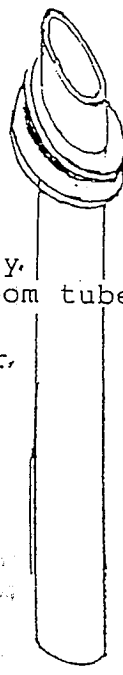
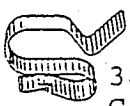

183. '64 Plym. door bumper

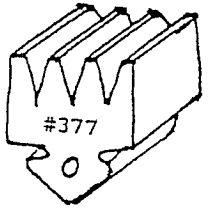
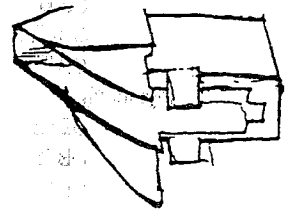

#377 '71 Door bumper most A,B,E Bodies



396 '68-'72 Door lock rod clip

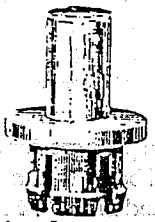

408 '63-'66 A body Rivet--window glass to lower channel

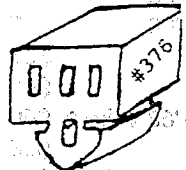

#376 '72-'79 Door bumper most models

#336 '60-'63 Imp. Fr. doors on 2dr., 4dr. & conv.

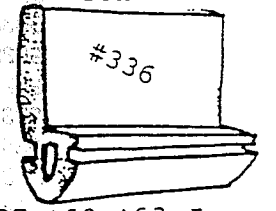

#337 '60-'63 Imp. Back doors on 4drs

#349 '65-'66 Chrys. Division bar cushions R&L (exchange only)

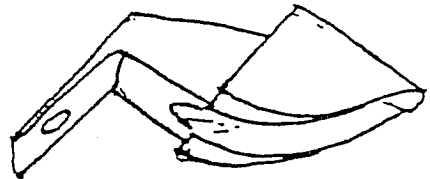

143. Nickel Plated Plug for 3/4 hole

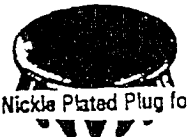

58. Door handle snubber '56, also '57-'62 on inner arms of handle (some)



31. A. '55 Chrysler & DeSoto (See #58)
B. '57-'62 Chrysler & DeSoto

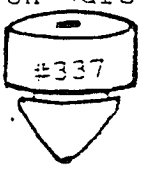

#337

S-1



391

'50s-'60s
12-24x $\frac{1}{2}$ " Phillips oval
head screw w/lock wsh
Attach door latch



Door Jamb Switch
A.'57-'59 \$5.25

B.'60-'73 \$5.15

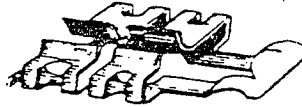

385
'64-'68 fr/'66-'68 rr
Clip--door lock lever

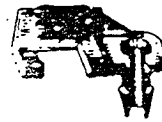

384

'69-'70 Clip--door lock
rod end

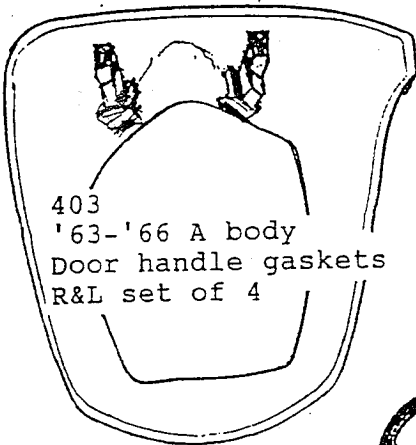

403
'63-'66 A body
Door handle gaskets
R&L set of 4



WINDOW REGULATOR FASTENER

159

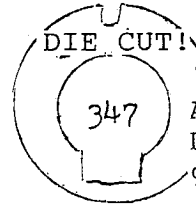

DIE CUT!

'63-'65
A,B&C-body
Door lock
gasket

'64 Dodge door
hinge pin seal.
Probably fits others.



329

#423 '66up die-cut nylon
gasket, (see #134 under trunk)
Exc. Dodge 880/ Imperial

↑ USE
W20

#514 Rear of rear door
'57-'59 Imperial 4 dr. sedan

#512. Front of rear door
'57-'59 Imperial 4 dr. sedan

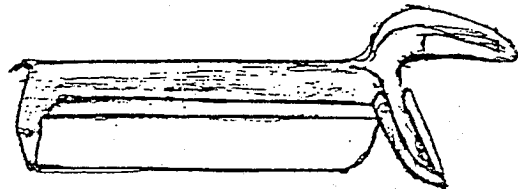

#456 '55-'56 Dodge, Ply.
HT & conv. vent frame to
door seal
(R & L required)

112. Molded w/strip at vent

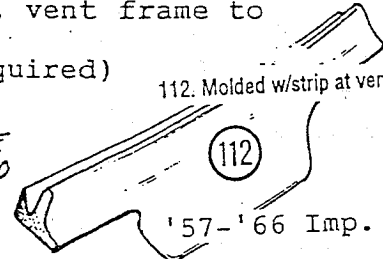

'57-'66 Imp.

39. Molded weather strip at vent '60-'64 Full
size cars

↓ USE
W11

#511 '57-'60 Imp.
2drHT & convert.
door w/s end
(4drHT?)

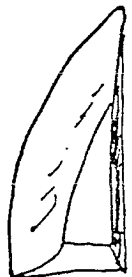

#515 '60 Imp. convert.
(H.T.?) small sponge
fillers on door jamb by
 $\frac{1}{4}$ window.

↓ USE
W20

↓ USE
W2

#513 Rear of front door
'57-'59 Imperial 4 dr.
sedan



↓ USE
W20

#38 Molded w/s at vent
'58-'59 exc. Imperial

38

39

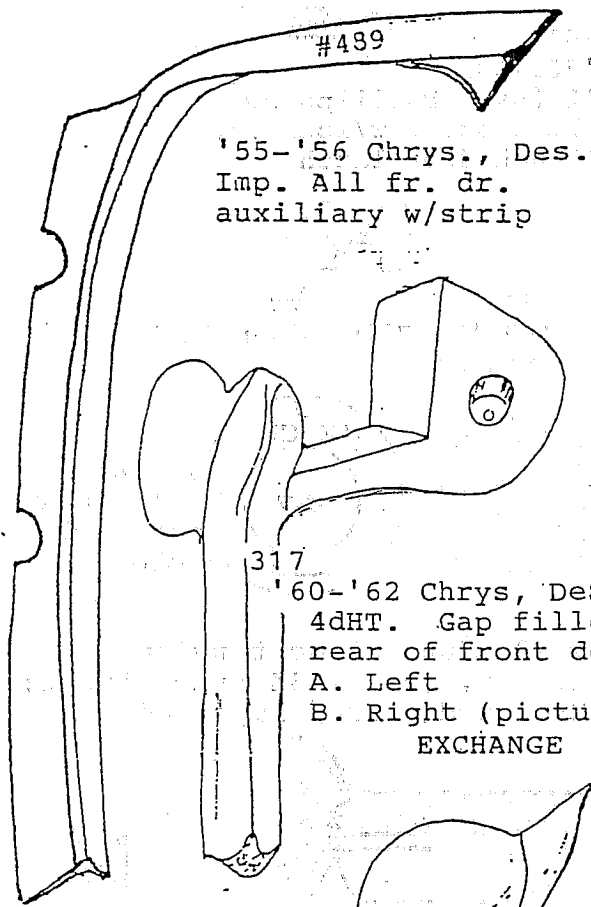

#489
'55-'56 Chrys., Des.
Imp. All fr. dr.
auxiliary w/strip

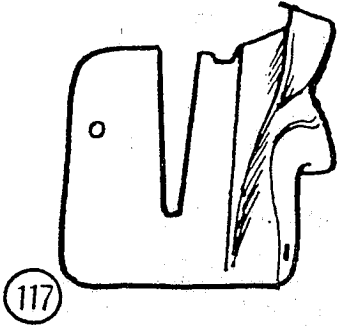

117. Door post/quarter window gap filler '63, '64 Chrys. Exchange

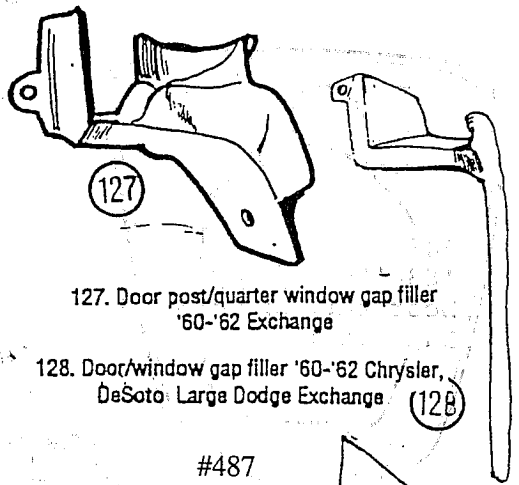

127. Door post/quarter window gap filler '60-'62 Exchange

128. Door/window gap filler '60-'62 Chrysler, DeSoto; Large Dodge Exchange (128)

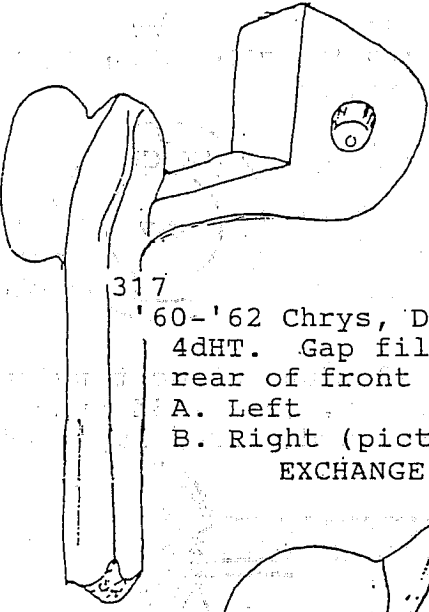

317
'60-'62 Chrys, DeSoto
4dHT. Gap filler at
rear of front door
A. Left
B. Right (pictured)
EXCHANGE

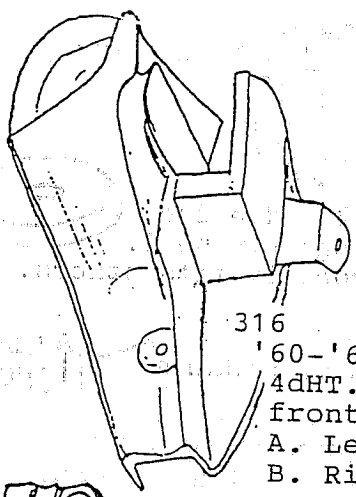

316
'60-'62 Chrys, DeSoto
4dHT. Gap filler at
front of back door.
A. Left (pictured)
B. Right EXCHANGE

#487
R & L

Auxiliary dr.
w/strip
'57-'63 Imp.
all fr. dr.

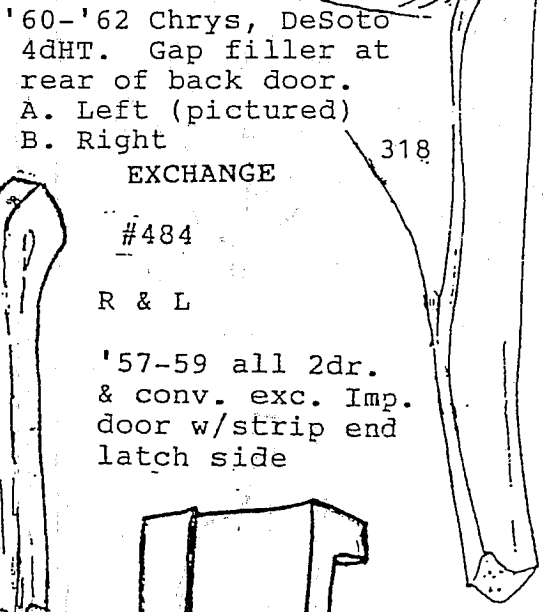

'60-'62 Chrys, DeSoto
4dHT. Gap filler at
rear of back door.
A. Left (pictured)
B. Right
EXCHANGE

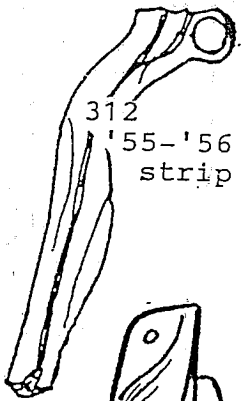

312
'55-'56 Door weather-
strip ends. R&L

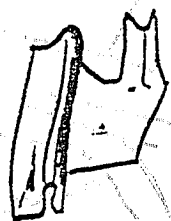

370 '68-'70 B-Body
door lock pillar seals,
molded with steel cores.
R & L

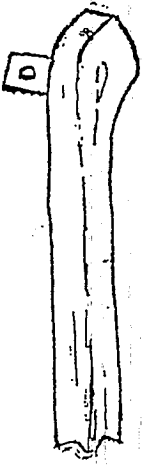

#484
R & L
'57-'59 all 2dr.
& conv. exc. Imp.
door w/strip end
latch side

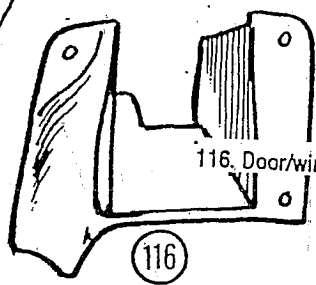

116. Door/window gap filler '63, '64 Chrys.
Exchange only

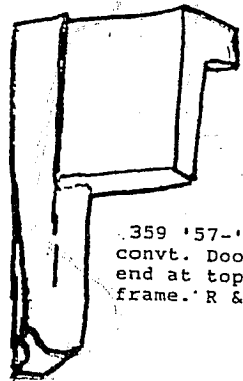

359 '57-'59 Imp.
convt. Door w-strip
end at top of vent
frame. R & L

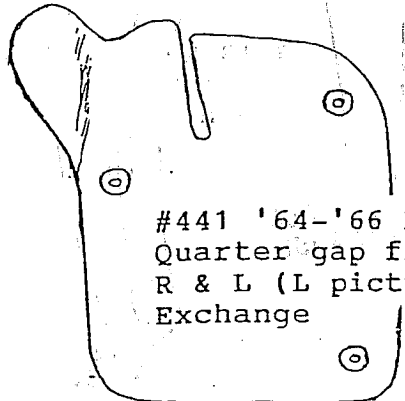

#441 '64-'66 Imp.
Quarter gap filler
R & L (L pictured)
Exchange

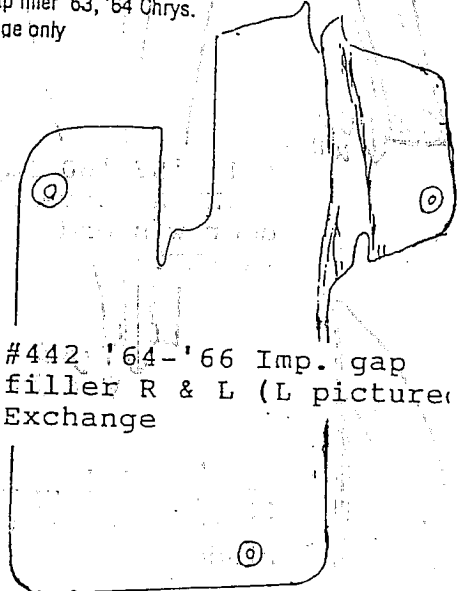

#442 '64-'66 Imp. gap
filler R & L (L pictured)
Exchange



369 '68-'70 B-Body door
jamb seal. Molded w/ steel
cores.

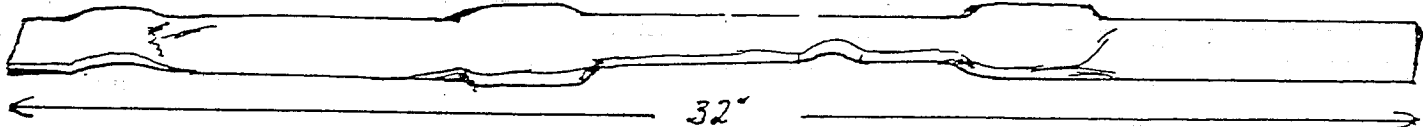

502. '39 Plymouth coupe molded weatherstrip on front edge of door. R or L

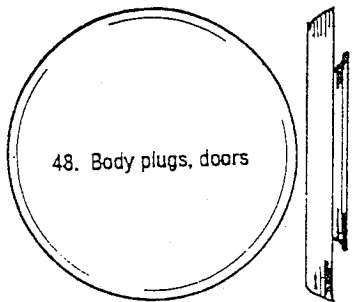

48. Body plugs, doors

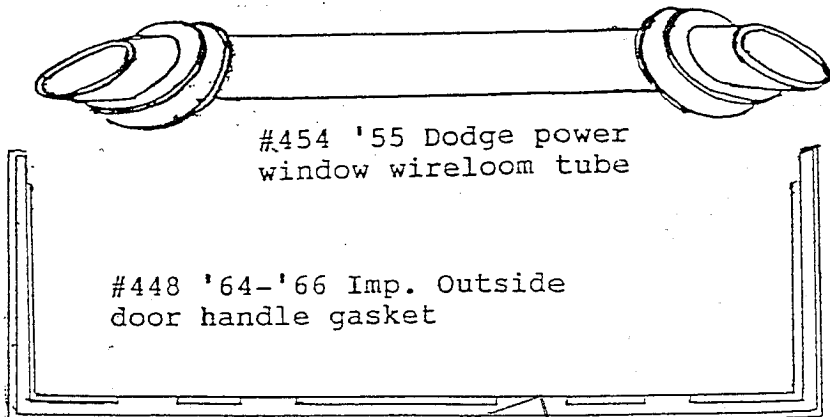

#454 '55 Dodge power window wireloom tube

#448 '64-'66 Imp. Outside door handle gasket

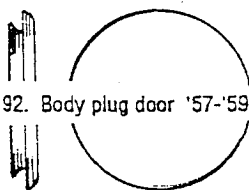

92. Body plug door '57-'59

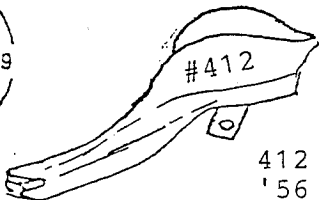

#412



#509 stainless steel screws for upper vent window pivot '57-'64

W59 R & L '66-'70 B-body conv. auxiliary seal on w/shield post \$15.00 each

412 '56 Dod, Ply, 2d HT, Cvt. Door weatherstrip end, R&L

DOOR WEATHERSTRIP

W21	'50a All lwr/door flange	\$1.70ft.
W2	'55 - '56 All fr - dr frame	\$1.45ft.
W2	Dart/Val. vntw.fr	\$1.45ft.
W14	'55 - '64	\$2.05ft
W20	'63 - '73 Incl sedans	\$2.10ft.
W20	'60 up Imperial	\$2.10ft.
W101	'68 - '71 B - body w/clp&ends	\$1.15set
W102	'70 - '74 E - body w/clp&ends	\$1.15set
W11	'50 - '70 General Purpose	\$2.15ft.
	(flatter profile than W20)	

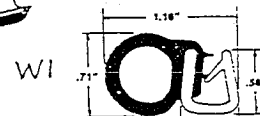
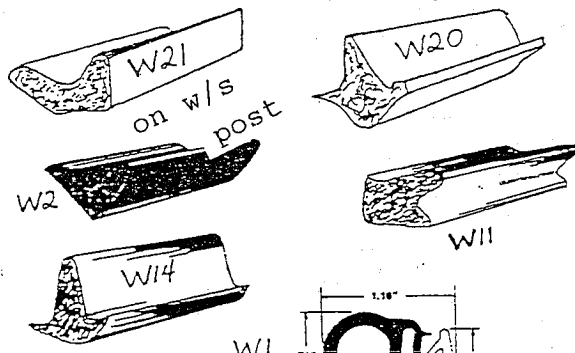

Edge trim and seal black only \$42.00/25ft roll

Chrysler style windlace-weatherstrip combo is no longer available, either original or cloth reproduction, I still have some colors in cloth which resembles a soft close-weave canvas. I need a color sample for best match. Price is \$13.00/yd

(See W1 on this page for Drawing)

QUARTER WINDOW WEATHERSTRIP

W99	'53 - '54	\$35pr.
W22	'55 - '56	\$35pr.
W17	'57 - '59 Exc. Imperial	\$35pr.
W33	'57 up Imperial w.o ends	\$22pr.
W19	'60 - '62 C-body	\$22pr.
W31	'65 up C-body	\$22pr.
W23F	'63 - '66 A - body flocked	\$31pr.
W126	'62 - '66 B - body flocked	\$31pr.
	'63 - '64 C - body flocked	\$31pr.
	'64 - '66 Imperial	\$31pr.

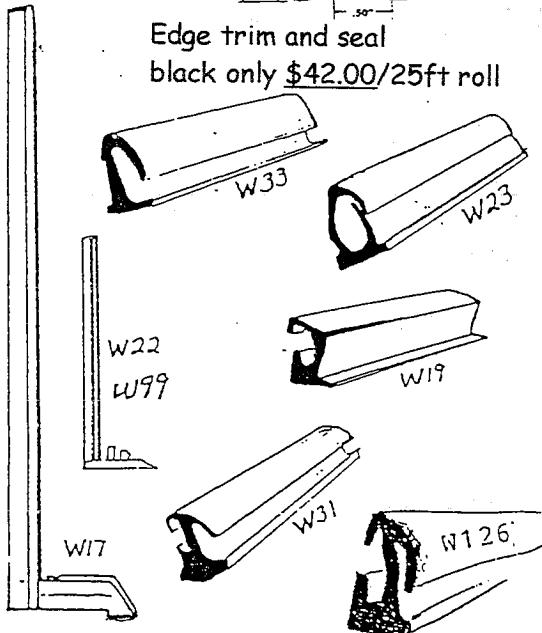

GLASS RUN CHANNELS

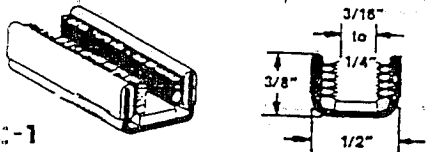

C-1 '55 - '56 division bar \$9.50 Each

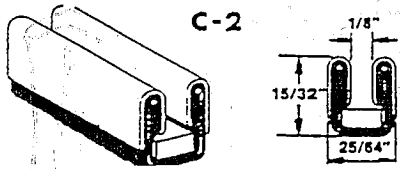

C-2 '55 - '59 Hts and Convs inside front doors \$11.75 Each

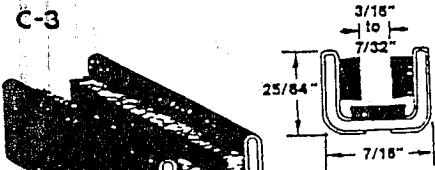

C-3 '57 - '59 Division bar \$10.25 Each

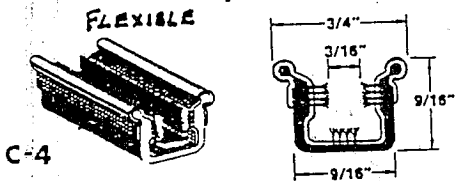

C-4 '55 - '56 4dr. Closed models front & rear \$24.00 Each 96"

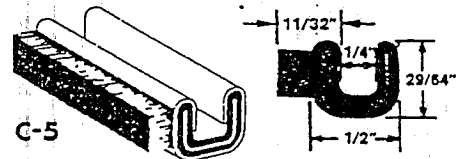

C-5 '55 - '56 SW tailgate \$24.00 Each

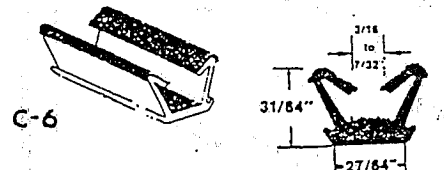

C-6 Division bar B - body 4dr sedan all models \$14.00 Each 96"

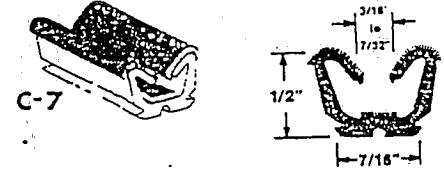

C-7 60 -'62 Valiant/Lancer closed models \$14.00 Each 96"

FLEXIBLE CHANNEL LINING

C-9 '65 channel and division bar
FR-dr, rr-dr. Qtr-window
96" \$18.00

C-9 '66 - '67 Rear-door. Channel
complete 96" \$18.00

C-10 '60 cars replacement
96" \$18.00

W110 '64 up Only available inner
belt weatherstrip with
stainless top edge
72" \$19.25

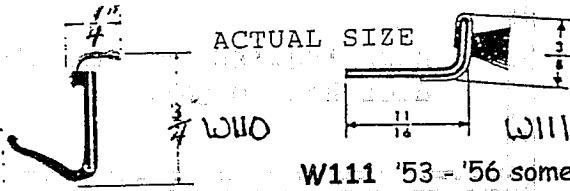

W111 '53 - '56 some cars, '53 - '63 trucks. Belt w/s
72" \$19.25

W120 '57 rear side
glass setting rubber
\$16.00 Each

W121 Late '55 - '56, '57 -'59
all door glass bottom
Channel rubber \$10.25 Each

W122 Early '55 door glass
bottom channel Rubber
\$11.25 Each

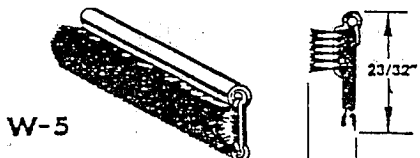

W-5 '55 -'63 most inner & outer
state length \$6.75/panel

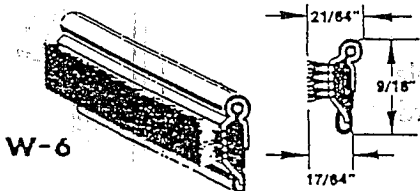

W-6 '61-'66 small cars
'64 some big cars
state length \$5.85 /panel

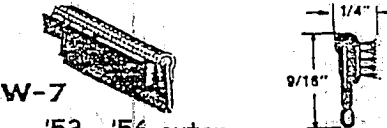

W-7 '53 - '56 outer
state length \$6.50/panel

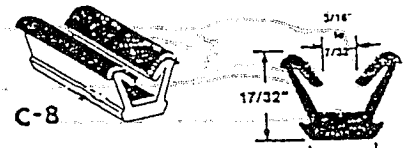

C-8 '63 '68 Dart/Valiant
division bar \$12.50/96"

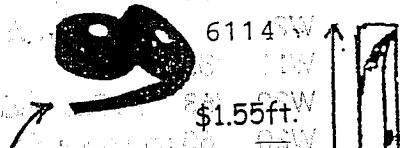
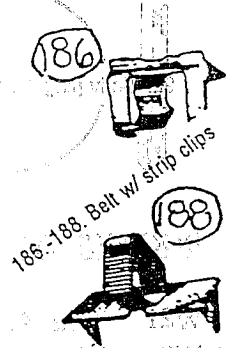
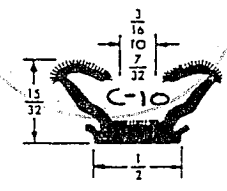
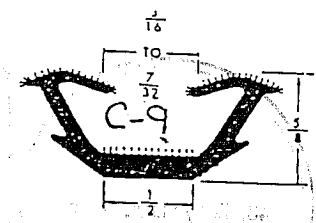

MOHAIR CHANNEL LINER
is a black mohair
lining material with
rubberized backing.
Apply adhesive to back
of liner and bond to
badly worn division
bars and channels.



508. Upper vent window
pivot. '62 Val.,
Lancer 2 & 4 door,
suburban

'65-'66 Dart ht & conv.
Also B-body. Auxillary
door seal on vent frame.
Slightly different than
'63-'64, but will fit &
work. \$5.50 Each W109

'57-'59 STATION WAGON AND 4 DOOR SEDAN PARTS

**'63-'66 A-BODY
STATION WAGON**

NOTE: Due to the extremely limited market for station wagon rubber, the tailgate and door weatherstrips are made up from a combination of several different sponge extrusions super-glued together. W133 and W134 were specifically made for station wagons. My '59 DeSoto wagon with aluminum window frames was the source of samples for the molded parts.

Some weatherstrip items listed have been simplified to work better. I'll refund the difference--They're cheaper!

- Tailgate inner belt weatherstrip. (4ft pc.) \$7.85ea.
- Front door division bar. (C3) \$10.25ea.
- Front door glass top and rear channel. (C11A-60"pc) \$14.75ea.
- Rear door glass channel. (C11B-96"pc) \$14.75ea.
- Tailgate glass upper channel-in body. (C12K-1x60"pc; 2x15"pcs) \$22.75ea.
- Tailgate glass lower channel-in tailgate. (C13K-2x18"pcs) \$23.00
- Tailgate glass bottom frame setting tape. ES15116 \$12.30
(Can also be used to set top and sides stainless frame.)

W131 Chrome plastic lockstrip used with W130. Enough for one side. \$18.00



W130 \$65
'63-'66 A-body SW. Rear side glass seal--enough for one side.

W115K
Front door weatherstrip kit. (Does not include molded parts--see #436, #437) (Right and left) \$35.00ea

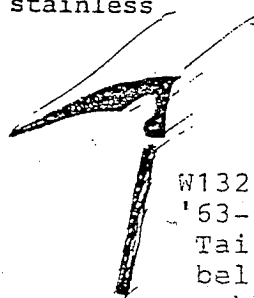

W116K
Rear door weatherstrip kit. (Does not include molded parts--see #438) (Right and left) \$35.00ea

W132 \$23
'63-'66 A-body StWgn Tailgate window outer belt w/s (Extra flat rubber strip included for window to metal gasket)

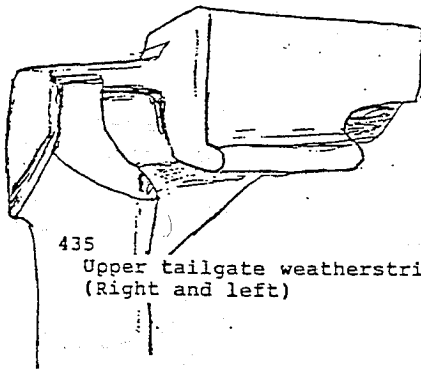
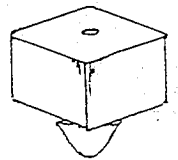

435 Upper tailgate weatherstrip end (Right and left)



434 Bumper on inside tailgate handle

#520
'63-'66 A-body SW tailgate bumper

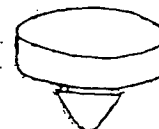

432 Tailgate-to-body bumper. 2 req'd

438 Rear door molded seal at rear joint of window frame and door (Right and left)

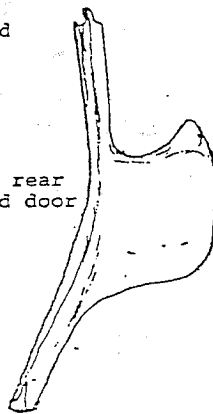

433 Tailgate power window wire loom tube 2 req'd--body and tailgate

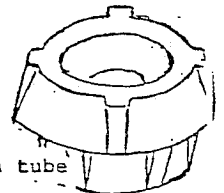

436 Front door molded seal at vent window (Part of door w/s) (Right and left)

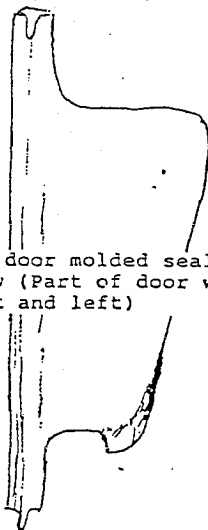

439 Front door bumper

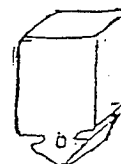

#W133
Tailgate window Outer belt w/strip \$18.00ea



#W134
Rear side glass setting rubber \$26.00ea



437 Front door molded seal at rear joint of window frame and door (Part of door w/s) (Right and left)

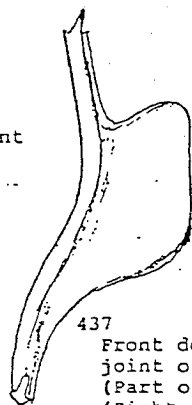

W114K
Tailgate weatherstrip w/o ends (See #435) \$40.00

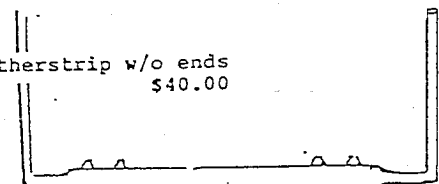

TRUNK

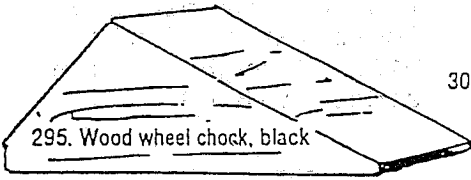

303. '65 Imperial trunk lid bumper

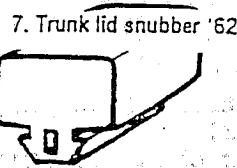
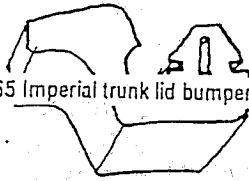

7. Trunk lid snubber '62

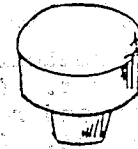

25. Trunk lid snubber '65

64. Trunk lid snubber '63 Imp.

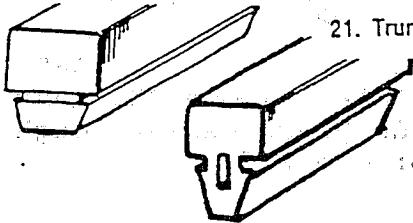

53. Trunk light wire grommet '55-'59



280. Trunk snubber, '55 Dodge

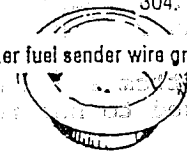

304. '57-'58 Imperial trunk lid bumper

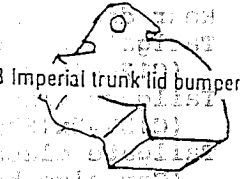

21. Trunk lid snubber '60-'61

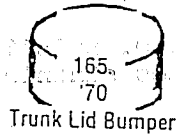

165-'70 Trunk Lid Bumper

207. '60 & later fuel sender wire grom.

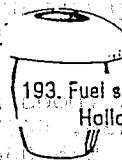

8. Trunk lid snubber '57-'59

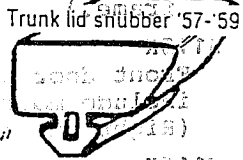

110. '57-'59 fuel gauge wire grommet

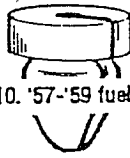

193. Fuel sender wire grommet '57-'59 Hollow. see #110 for solid

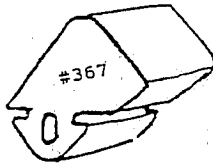
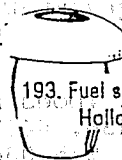

#367

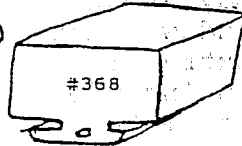

#368

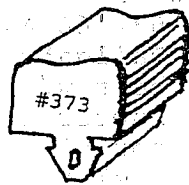

#373

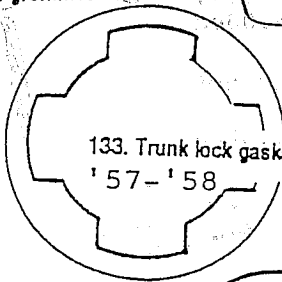

133. Trunk lock gasket '57-'58

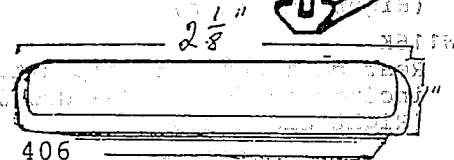

406

'63-'66 A body Trunk body plug Rectangular--2 per trunk

#373 '63 Belvedere '64 Polara, trunk

#367/#368 '61 Imp. trunk lid bumpers. (also see #64)

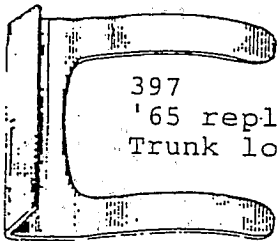

397 '65 repl 2583377 Trunk lock rtr

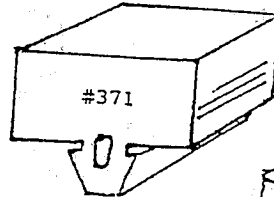

#371

#371 '66-'74 B-Body Trunk lid bumper.

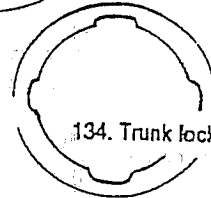

134. Trunk lock gasket '59-'64

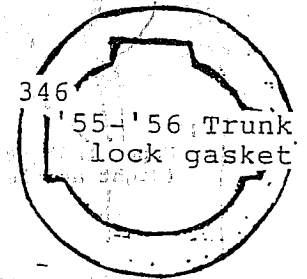

346

'55-'56 Trunk lock gasket

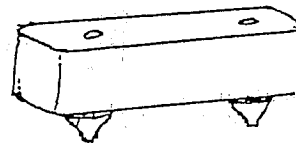

#445 '67 Imp. trunk snubber

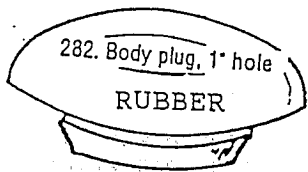

282. Body plug, 1" hole RUBBER

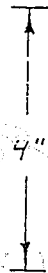

120. Body plug '55, '56 trunk

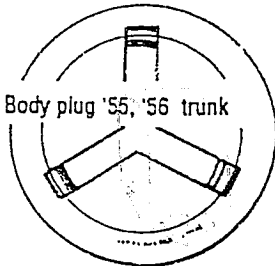

W106

Rubber edging (actual size) Goes around edge of metal spare tire cover '57-'62. Many general uses see #W107 \$1.70/ft.

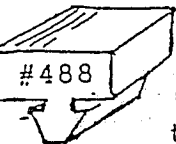

'56-'57 Chrys., Des. trunk snubber (see #8 for some '57)

TRUNK WEATHERSTRIP

W8	'55-'56 All makes	\$38
W9	'57-'59 All makes	\$42
W10	'60-'62 All makes (exe. Intermediats)	\$45
W10	'63 Imperial	\$45

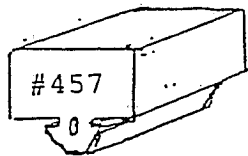

#457 '63-'66 A-Body trunk lid snubber

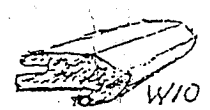
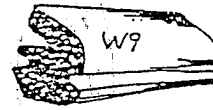
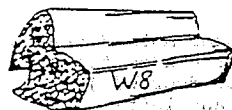

TRUNK WEATHERSTRIP

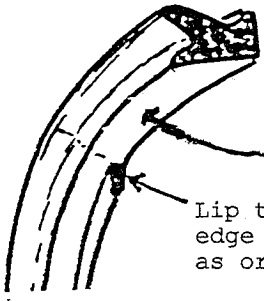

Glue surface
Lip to cover inside edge an sides & top as original.

TRUNK SEALS

One piece seals with two Different profiles as original \$34 Each

TS1	'63 - '66 Dart
TS1	'63 - '66 Valiant
TS2	'63 - '65 Dodge B - body
TS2	'63 - '65 Plymouth B - body
TS3	'63 - '64 Chrysler
TS4	'64 - '66 Imperial
TS5	'65 - '66 Chrysler
TS5	'65 - '66 C - body
TS5	'65 - '66 Dodge C - body
TS5	'65 - '66 Plymouth C - body
TS6	'66 - '67 Dodge B - body
TS6	'66 - '67 Plymouth B - body
TS7	'66 - '67 Dodge Charger
TS18	'66 Barracuda

TS8	'67 - '69 Barracuda Fstbk
TS15	'67 - '68 Chrysler
TS15	'67 - '68 C-body
TS15	'67 - '68 Dodge C-body
TS15	'67 - '68 Plymouth C-body
TS6	'67 Plymouth
TS10	'67 - '68 Imperial
TS9	'67 - '70 Dart
TS9	'67 - '70 Valiant
TS12	'68 - '69 Roadrunner
TS12	'68 - '69 GTX
TS11	'68 - '70 Coronet R/T
TS11	'68 - '70 Superbee
TS13	'68 - '70 Charger
TS14	'69 - '70 Chrysler
TS14	'69 - '70 C-body
TS14	'69 - '70 Dodge C-body
TS14	'60 - '70 Plymouth C-body
TS16	'69 - '70 Imperial
TS11	'70 Roadrunner
TS11	'70 GTX
TS17	'70 E - body

375 Early '70 trunk seal A & B-body, Sponge seal Made Like Original. Compare Yours to Illustration.

#375

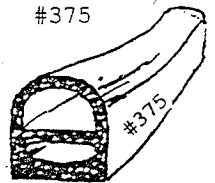

TRUNK CARPETS

Cut, sewn and edged as original. Notches for some latches. braces, Spare tire hold down, and jack hold down not cut out. For '55-'61 carpets are gray cut pile custom manufactured to match original. '57-'61. This is not original tecture for '55, '56. To my knowledge no one has ever found any originsl material. For '61-'62 Chrysler, carpets are black cut pile custom designed to replace original rubber mat. For '63-'64 Chrysler, & '64 Imperial, carpet are synthetic felt-like material that resembles original. For '65-up Chrysler, carpets are black loop pile.

IMPRERIAL

TC1	'55	\$92
TC2	'56	\$92
TC12	'57 - '59	\$80
TC13	'60 - '61	\$88
TC14	'62 Gray c -pil	\$75
TC15	'63 Gray c -pil	\$90
TC25	'63 Gray/black	\$102
Loop like original		
TC16	'64	\$83
TC17	'65 -'66 w/pad	\$83
TC27	'67 -'68 w/pad	\$83
TC22	'69 -'72 w/pad	\$83
TC2	'73 w/pad	\$83

DODGE

TC19	'55	\$73
TC20	'57-59 gray	\$75
TC4	'60-'61	\$75
TC21	'63-'66 A-body	\$35
plaid vinyl		

CHRYSLER/DESOTO

TC1	'55	\$92
TC2	'56	\$92
TC3	'57-'59	\$75
TC4	'60-'61 gray	\$75
TC5	'61 black	\$68
TC6	'62	\$68
TC7	'63-'64	\$70
TC8	'63-'64 cnvt.	\$70
TC9	'65	\$80
TC29	'66	\$73
TC10	'67-'68	\$80
TC11	'69-'72	\$83
(Inc. pad)		

PLYMOUTH

TC18	'57-'59	\$75
TC4	'60	\$75

SPARE TIRE COVERS TO MATCH TRUNK CARPETS

TC27	'55-'56	\$43
TC28	'57 and up	\$43

TRUNK PANELS

Custom cut from original patterns, Scored and edged as original. ready to install. Set includes right and left side panels wrapped around trunk hinge and wheelwell area, panel behind rear seat, and panels under rear lip where original. Generally, Chrysler Panels are gray until '61, then black; Imperial panels are gray until '63, then black; dodge and plymouth are all gray.

PLEASE NOTE: Minimum Shipping and handling on one set of panels is \$24 Each. As they require an oversized box. best way is to include other parts you need, or combine an order with friends in your area on shipping.

CHRYSLER/DESOTO

TP1	'55	\$80
TP2	'55 conv.	\$73
TP3	'56	\$80
TP4	'56 conv.	\$73
TP5	'57-'59	\$80
TP6	'57-'59 conv.	\$73
TP7	'60	\$77
TP8	'60 conv.	\$77
TP9	'61 blk or gray	\$77
TP10	'61 conv. blk/gry	\$77
TP11	'62	\$77
TP12	'62 conv.	\$77
('60-'62 300 letter car series HT are \$ 5 less no divider board)		
TP13	'63-'64	\$80
TP14	'63 conv.	\$80
TP15	'64 conv.	\$80
TP16	'65	\$80
TP17	'65-'66 conv	\$77
TP18	'67-'68	\$75
TP19	'69-'72	\$85

PLYMOUTH

TP30	'56	\$77
TP46	'56 conv.	\$71
TP31	'57-'58	\$80
TP32	'57-'58 conv.	\$83
TP33	'59	\$77
TP34	'59 conv.	\$70
TP58	'60	\$75
TP55	'60 conv.	\$70
TP35	'61	\$75
TP53A	'62-	\$75
TP54	'62 conv.	\$70
*TP56	'63-'65 B-body	\$40

IMPERIAL

TP20	'55	\$80
TP3	'65	\$80
TP21	'57-'59	\$80
TP22	'57-'59 conv.	\$61
TP23	'60-'61	\$77
TP60	'60-'61 conv.	\$75
TP25	'62	\$85
TP44	'62 conv.	\$83
TP26	'63	\$80
TP45	'63 conv.	\$75
TP27	'64-'66	\$83
TP28	'64-'66 conv.	\$77
TP29	'67-'68	\$85
TP59	'67-'73 conv.	\$85
(incl. rt. side masonite pnl)		
TP43	'69-'72	\$85
TP57	'73	\$85

DODGE

TP50	'55 Speckled gray	\$80
TP47	'56 "	\$80
TP37	'57-'58 tan	\$82
TP37	'57-'58 gray	\$80
TP38	'57-'58 conv. (tan)	\$75
TP38	'57-'58 conv. (gray)	\$73
TP39	'59	\$80
TP40	'59 conv.	\$77
TP41	'60	\$80
TP49	'60 conv.	\$73
TP53B	'63 B-body	\$75
TP42	'63	\$75
*TP65	'65 Coronet	\$40

*(masonite Filler piece From $\frac{1}{4}$ panel to Trunk Floor)

Minimum Shipping and handling is \$45.00 to east coast. S/H is less, IF you are closer to here. Other parts can be shipped in the Same OVERSIZED Container. I will refund Excess shipping charges.

JACK INSTRUCTION SHEETS

- J13 '56 Chrysler
- J14 '56 Desoto
- J1 '57 Chrysler
- J10 '57 DeSoto
- J2 '58 Chrysler
- J11 '58 DeSoto
- J3 '59 Chrysler
- J12 '59 DeSoto
- J4 '60 Chrysler
- J4 '60 Desoto
- J56 '60 Chrysler Sta. Wag.
- J16 '60 Dodge
- J18 '60 Imperial
- J68 '60 Plymouth
- J5 '61 Chrysler
- J5 '61 DeSoto
- J15 '61 Plymouth
- J52 '61 Imperial
- J6 '62 Chrysler
- J19 '62 Dodge
- J53 '62 Imperial

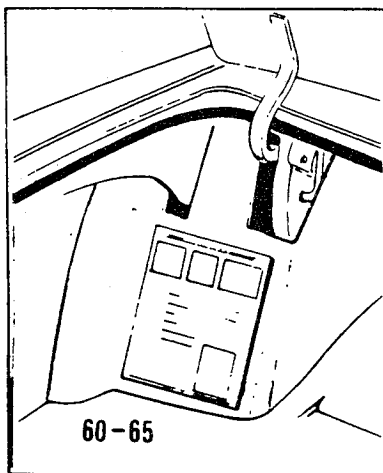
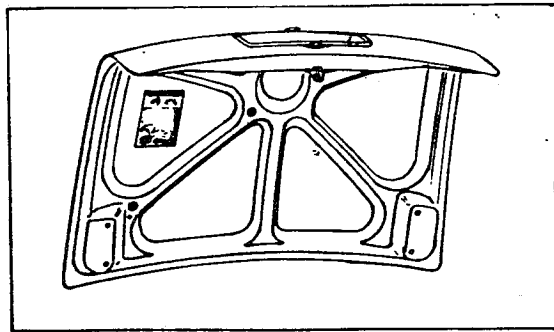

- J55 '62 Plymouth
- J7 '63-'64 Chrysler
- J23 '63-'64 Dodge/Plymouth
- J21 '63-'64 Dart
- J21 '63-'64 Valiant
- J54 '63 Imperial
- J22 '64 Imperial
- J8 '65 chrys.& Dod. (C-body)
- J58 '65 Plymouth
- J25 '65-'66 Dart
- J24 '64 Valiant
- J27 '65 B - body
- J30 '65-'66 Imperial
- J30B '66 Imperial with
Tire Psi. & Ld chart.
- J30 '65-'66 Imperial w/o chart
- J29 '66 Chrysler
- J29 '66 Dodge
- J50 '66 A-body
- J9 Sure Grip Instructions

Each one has been painstakingly recreated from the original. They are all printed accurately and clearly on the correct paper for each particular car. Complete your restoration with these high quality reproductions. ALL \$4.00 Each.

UNDER HOOD

HOOD PADS

HP1 '57-'59 Chrys. DeS	\$18	HP35 '65 Dodge B-body	\$24
HP2 '57-'58 Dodge	\$18	HP17 '65 Dart	\$24
HP3 '57-'59 Plym, Imp	\$18	HP18 '64 Ply	\$24
HP4 '60 Chrys., DeS	\$18	HP19 '66 C-body	\$24
HP5 '60 Imperial	\$18	HP33 '66 Dodge B-body	\$24
HP30 '60 Dodge	\$18	HP20 '66 Dart	\$24
HP31 '60-'62 Lancer	\$18	HP21 '66 Valiant	\$24
HP6 '61 Chrys., DeSoto	\$24	HP22 '67-'68 C-body	\$24
HP7 '61-'63 Imperial	\$24	HP29 '67-'68 Imp	\$24
HP8 '62 Chrysler	\$24	HP32 '67-'69 Dart	\$24
HP9 '63-'64 Chrysler	\$24	HP36 '68 Dodge B-body	\$24
HP10 '63-'64 Dart	\$24	HP23 '69-'72 Chrysler	\$24
HP11 '63 Ply. Spt/Fury	\$24	HP24 '69-'72 Imperial	\$24
HP12 '64 Dodge Polara	\$24	HP25 '73-'75 Imperial	\$24
HP13 '64 Ply, spt/Fury	\$24	HP26 '74 Dart, Valiant	\$24
HP14 '64-'65 Imperial	\$24	HP27 '75 Chrysler	\$24
HP15 '64-'65 Valiant	\$24	HP28 '75-'79 Cordoba	\$24
HP16 '65 C-body	\$24		

Hood Pad Clips

#290 Black plastic hood pad fastener general purpos3 replacement

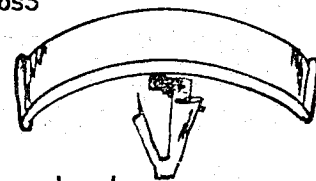

493. '63 & newer hood pad clip. Black Finish.

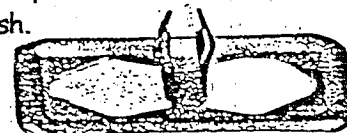

494. Early '60s hood pad clip. Black finish.

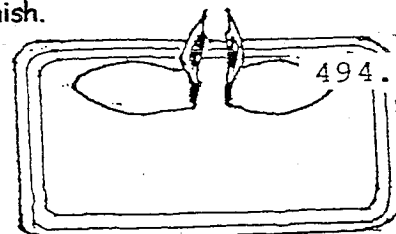

These pads are all cut out of 1/2" black fiberglass with a semi-rough coating on the outside. Holes punched where original for clips. Others without clip holes were glued on with contact cement.

192. '60 Chrys. trunk drain tubes
 A. Rear edge of trunk opening
 B. Center of lid to rear edge

55. Parking brake cable insulator '55-'59

78. Tubing & wire ties, nylon

93. Blower motor cooling tube '57, '58

194
 Battery tray drain tube
 A. '55-'59
 B. '60-'64
 (B looks like 192)

278
 '59-'64 All makes
 A/C case drain tube

172. 300 C.D.E. hood latch bolt

34
 '56-'59 Battery tray
 A. Large
 B. Small

124. Blower motor housing seal '57, '58

241. P/S pump-gen. drive '56 & older

131. Heater control valve seal

130. Heater control valve seal '57, '58

'55-'56

245. Heater core outlet seal

24. Steering shaft insulator

A. '55-'57
 B. '58-'64

119. '57 300 C air cleaner brackets

247. Heater core outlet seal '57, '58

#101 Wire type hose clamps

- A. 392 bypass hose 1" I.D.
- B. Gas hose 5/16" I.D.
- C. Brake booster hose 15/32 I.D.
- D. Heater hose 5/8" I.D.
- E. P/S return hose 5/8" I.D.
- F. 1 1/2" I.D. Upper radiator
- G. 1 3/4" I.D. Lower radiator
- H. 2" I.D. Lower radiator
- I. early 318 C.I. bypass hose
- J. For 3/8 I.D. booster hose

255. '60 & up "floating" P/S pump bumper

243. 1/8" x 1/8" tube connector

242. 1/8" x 1/8" x 3/10" plastic tee

#493

'63 & newer hood pad clip. Black finish.

415
 '60-'66 A body, 6 cyl
 Accel rod insulator, grn

290. Black plastic hood pad fastener
 General purpose replacement

#338 Fan shroud snubber
 '56 Chrys. Desoto

142. A..1/4-20 B..5/16-18

494. Early '60's hood pad clip. black finish.

#459 Early '50s firewall grommet 2 equal size holes
 (also see #27, 28, 29)

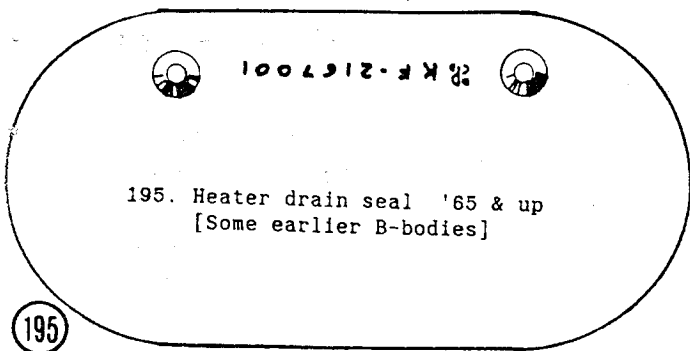

195. Heater drain seal '65 & up
[Some earlier B-bodies]

195

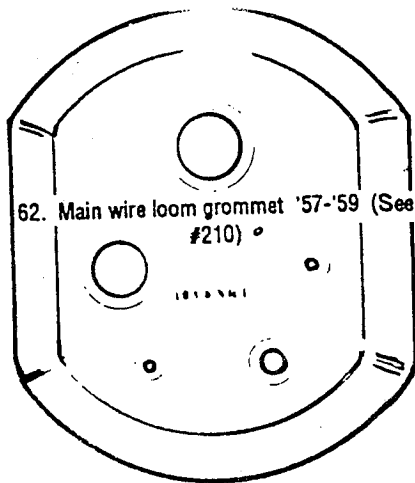

62. Main wire loom grommet '57-'59 (See #210)

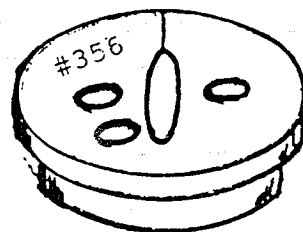

#356 '50-'54 Chrys. main wireloom gromm. on firewall

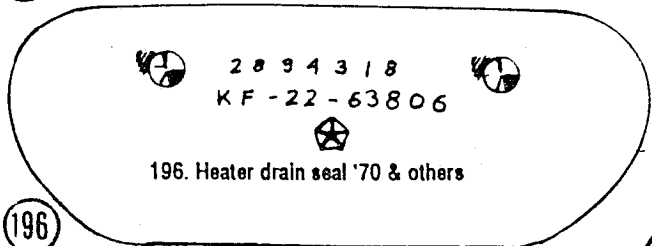

196. Heater drain seal '70 & others

196

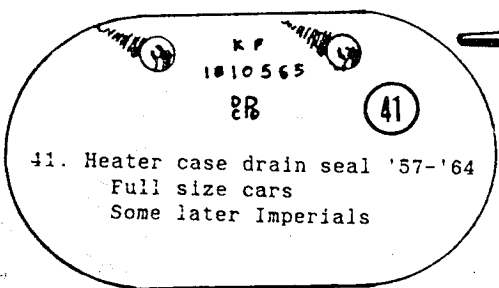

41. Heater case drain seal '57-'64
Full size cars
Some later Imperials

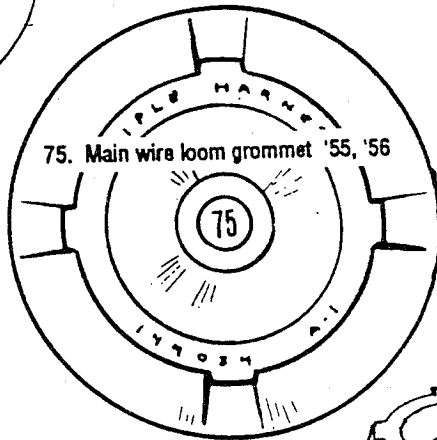
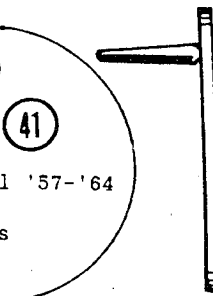

75. Main wire loom grommet '55, '56

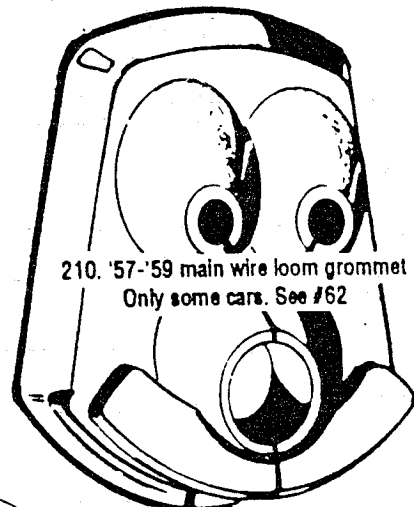

210. '57-'59 main wire loom grommet
Only some cars. See #62

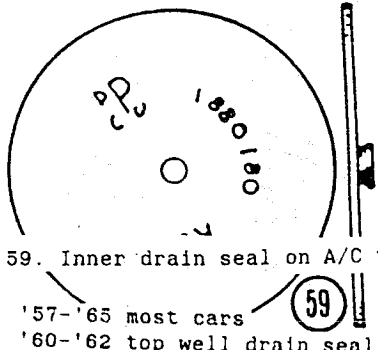

59. Inner drain seal on A/C units

'57-'65 most cars
'60-'62 top well drain seal

59

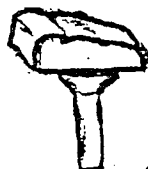

111. Speedo cable grommet '62

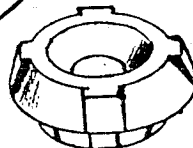

22. Fan shroud snubber '57-'65



274. Parking light grommet on inner fender.
'57, '58 Ply.



12. Air cleaner snubber '58, '59, '62 with dual air cleaners



191. Linkage bushing, '59-'64 see #14

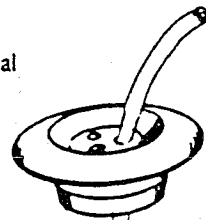

52. Tube & grommet (vacuum line) '59 & up

27. - 29. Firewall grommets '55-'59

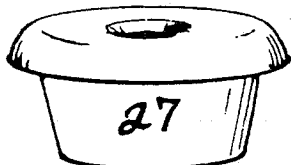

21. Trans cable grommet '56-'59

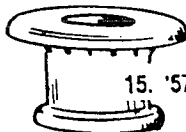
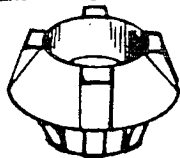

15. '57-'58 accelerator & trans linkage



14. Accelerator & trans linkage grommet '59-'64

#478 Wireloom retainer '60s vehicles- white plastic clip to wireloom & snapped into hole.

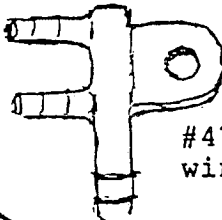
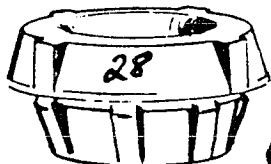

#471 '63-'70-A body windshield washer "T"

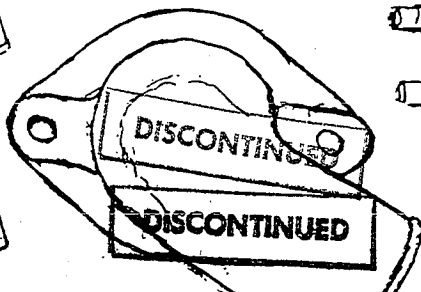
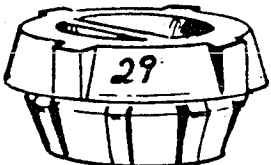

#468 Slant six thermostat housing-cast iron



#452 White plastic bushing for fuel linkage rod '60-'6 C-Body

416
Wire loom straps, hard
rubber, looks/works as
orig, act size drawings

#342 '79-'80 wire retainer
interior fender liner

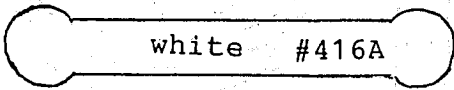

white #416A

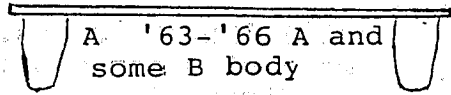

A '63-'66 A and
some B body



black #416B

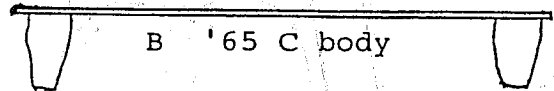

B '65 C body

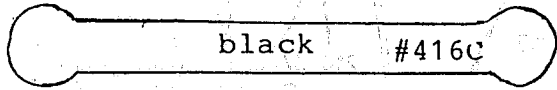

black #416C

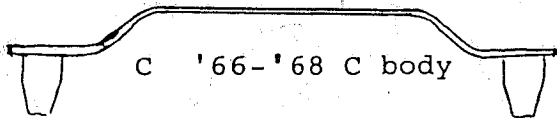

C '66-'68 C body

#363 '57-'59 A/C cars
grommet for A/C lines
through radiator core
support.



#363

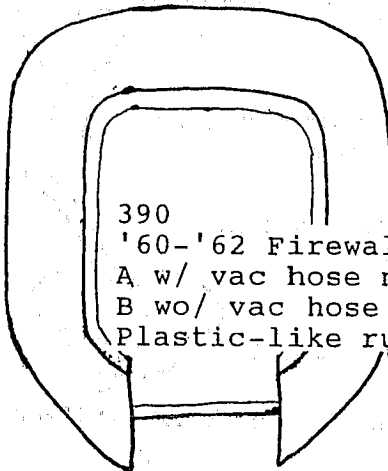

390
'60-'62 Firewall plug
A w/ vac hose nipple
B wo/ vac hose nipple
Plastic-like rubber

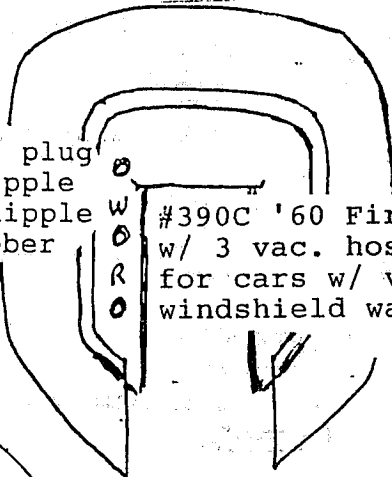

#390C '60 Firewall plug
w/ 3 vac. hose nipples
for cars w/ vac. operated
windshield washer system

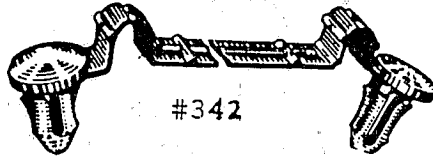

#342

#402 '62-'64 All Dart,
Val, Ply.-Dod exc. 880
steering shaft coupling
seal

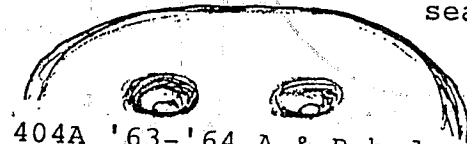
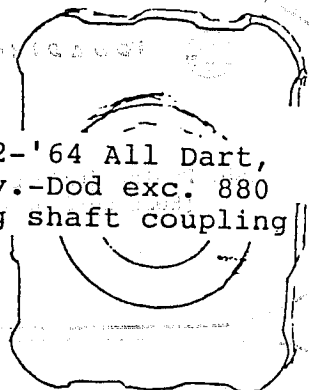

404A '63-'64 A & B-body
firewall grommet for trans
cables

404B '65-'66 Black plug
for auto trans.

#244
A/C line grommet in
rad. support. '58-'59
(see #363 this page)

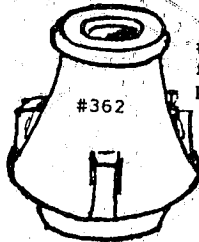
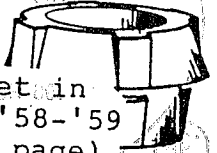

#362 '57-'58 A/C cars
firewall grommet for power
piston oil lines.

#362

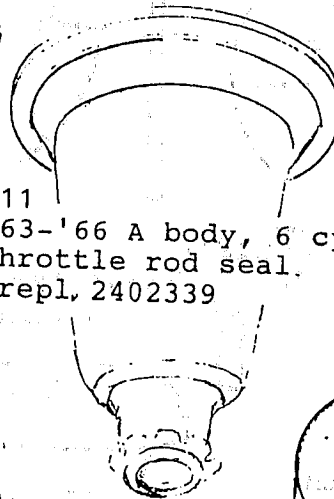

411
'63-'66 A body, 6 cyl
Throttle rod seal.
repl. 2402339

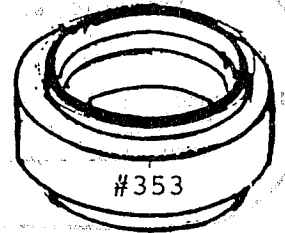

#353

Spark plug tube
seal '51-'58 all
Hemi engines

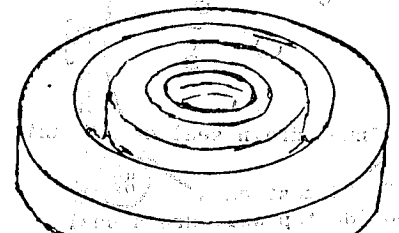

#410 '62-'66 A&B-body
steering shaft seal,
replaces 2266738 Bot. of
column, white plastic
center

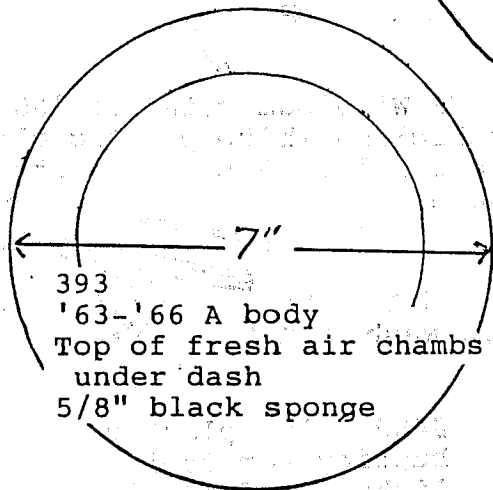

393
'63-'66 A body
Top of fresh air chambs
under dash
5/8" black sponge

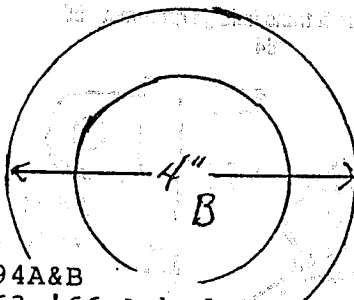

394A&B
'63-'66 A body
Blower motor plate--seals on firewall under hood
A--3/16" black sponge outer seal
B--5/8" black sponge inner seal

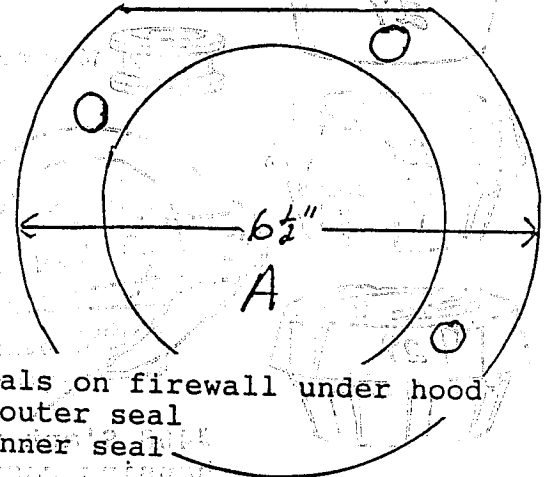

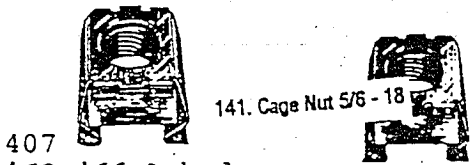

141. Cage Nut 5/8 - 18

407 '63-'66 A body
Cage nut-- $\frac{1}{4}$ -20 Inner
fender to metal splash
shield

A. $\frac{1}{4}$ -20x1 $\frac{1}{4}$ " for heater case
B. $\frac{1}{4}$ -20x3/4" for misc.
fenderwell mounted parts



171.

167. Wing nut A. 1/4-20
B. 5/16-18 C. 3/8-16

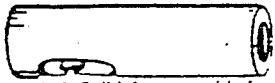

168. Ball joint assembly for fuel linkage. Male & female thread - 1/4 - 28

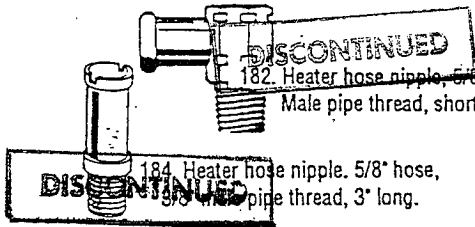

182. Heater hose nipple, 5/8" hose, 3/8" Male pipe thread, short elbow

184. Heater hose nipple, 5/8" hose, 3/8" male pipe thread, 3" long.

181. Heater hose nipple, 5/8" hose, 3/8" male pipe thread, 1 1/2" long

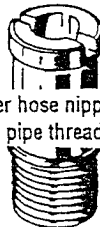

162. Engine to firewall ground wire.

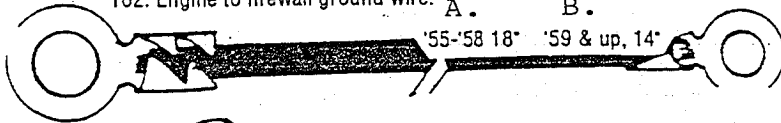

A. '55-'58 18" B. '59 & up, 14"



163. White plastic vacuum lines for ram cars [set of 2]



164. Linkage clip for rams

413 Early V8s RED plug wire boot

#189 Battery hold-down bolt

A. 3/8-16x10"
B. $\frac{1}{4}$ -20x9"



170. Fenderwell bolt 1/4 - 20

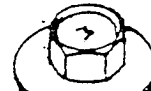

169. Fenderwell bolt 5/16 - 18

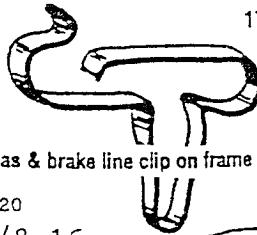

100. Gas & brake line clip on frame

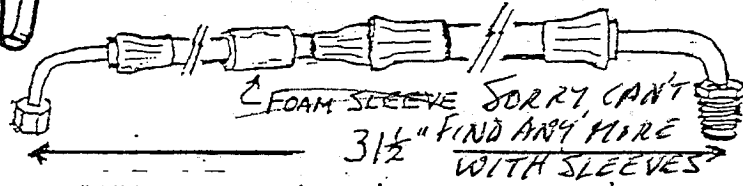

#479 Power steering pressure hose '57-'66 most A,B,C bodies, Imperial

#480 5/8" power steering return hose 3ft. length/

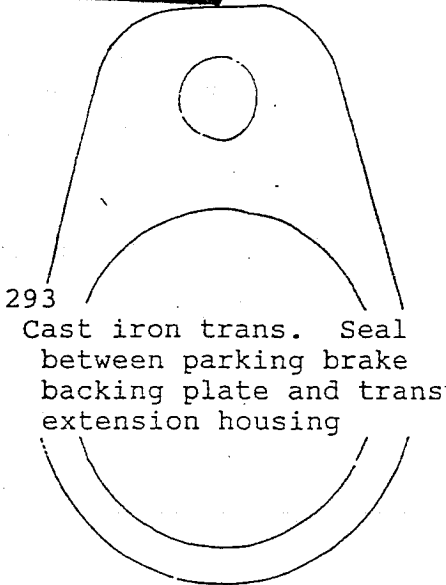

293 Cast iron trans. Seal between parking brake backing plate and trans extension housing

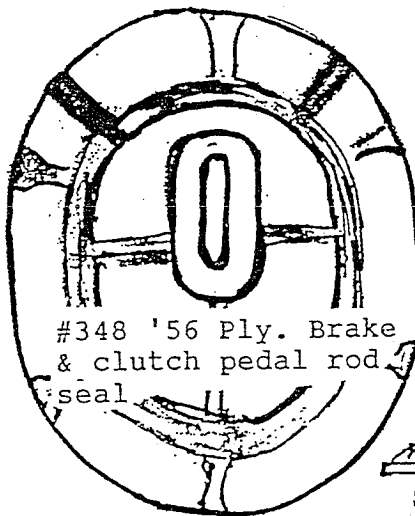

#348 '56 Ply. Brake & clutch pedal rod seal

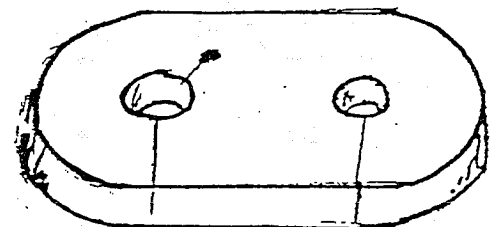

354 '59-'64 A/C line grommet 4 1/2"



Side view

320 '59&earlier? Gas heater parts
A. Bumper
B. Lg grommet
C. Sm grommet
D. Tube

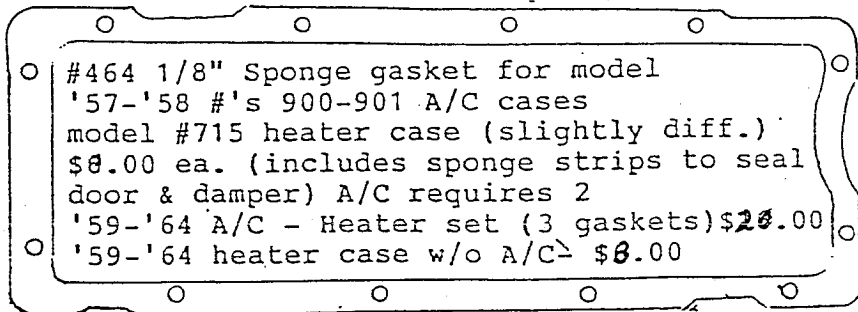

#464 1/8" Sponge gasket for model '57-'58 #'s 900-901 A/C cases model #715 heater case (slightly diff.) \$8.00 ea. (includes sponge strips to seal door & damper) A/C requires 2 '59-'64 A/C - Heater set (3 gaskets) \$28.00 '59-'64 heater case w/o A/C \$8.00

'55-'56 #8-20

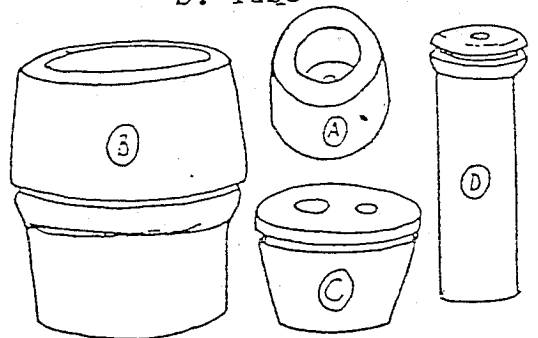

#510 '56-'60 starter, generator, distributor tags. Beautiful silkscreened aluminum tags complete your detailed restoration. Numbers stamped- \$15.00 each. You specify part no. and Auto-Lite No. serial number will be random. Blank tags- \$12

DISCONTINUED

DISCONTINUED

DISCONTINUED

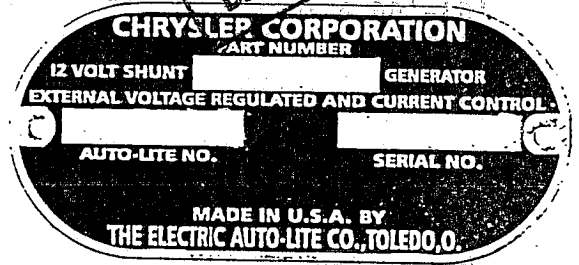
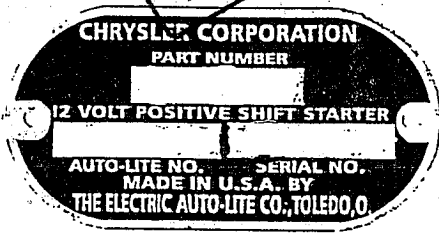
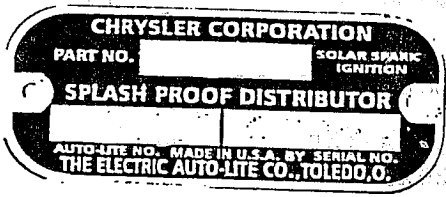

A. dist.

B. starter

C. gen.

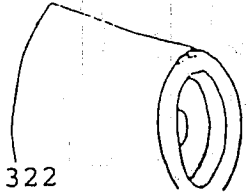

322 '59&earlier starter solenoid plunger boot



321 '59&earlier starter bendix drive lever boot

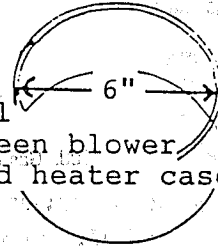

319 '57-'58 All Seal between blower motor and heater case

'63-'64 A-body Grommet in fire-wall for washer hose

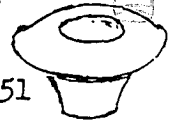

251

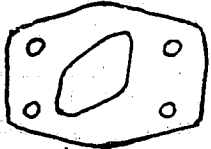

#331 Mid '50s-mid '60s master cylinder gasket die-cut heavy gasket paper

HOOD STOPS

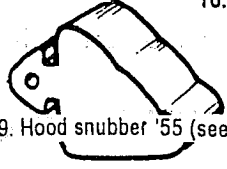

129. Hood snubber '55 (see #16)

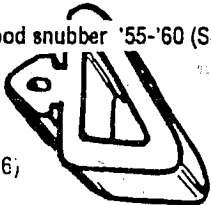

16. Hood snubber '55-'60 (See #129)

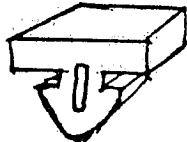

153. 56 Dodge Hood Snubber

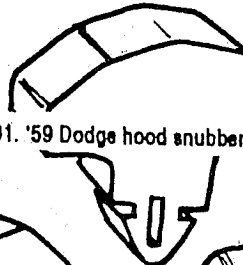

201. '59 Dodge hood snubber

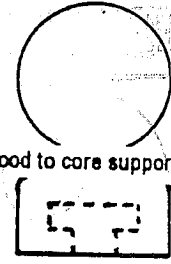

50. Hood to core support bumper '55-'61

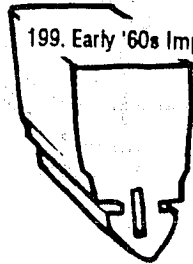

199. Early '60s Imp. hood snubber



208. '60-'61 Val. '61 Lan. hood snub

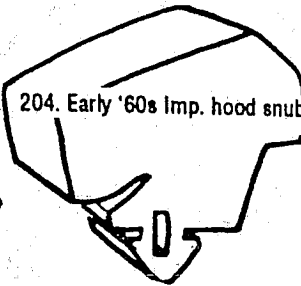

204. Early '60s Imp. hood snubber

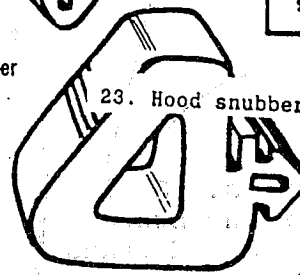

23. Hood snubber '61-'62 Chrysler [see #95]

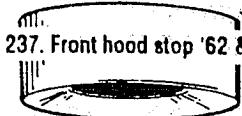

237. Front hood stop '62 & later

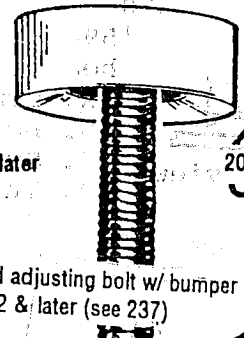

310. Hood adjusting bolt w/ bumper '62 & later (see 237)

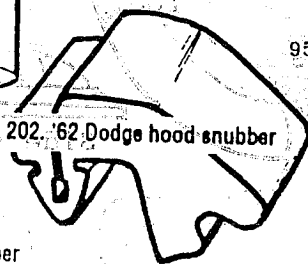

202. '62 Dodge hood snubber

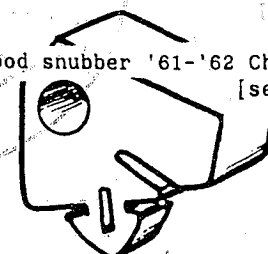

95. Hood snubber '61-'62 Chrysler [see #23]

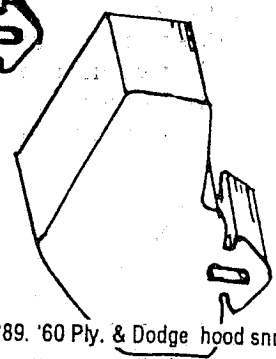

289. '60 Ply. & Dodge hood snubber.

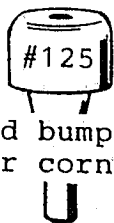

#125 Hood bumper, rear corner '63-'70

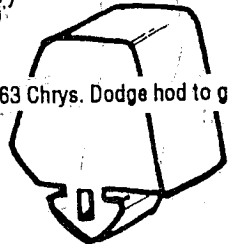

212. '63 Chrys. Dodge hod to grill

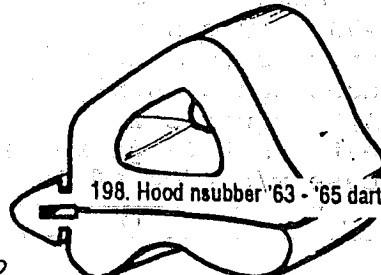

198. Hood snubber '63-'65 dart

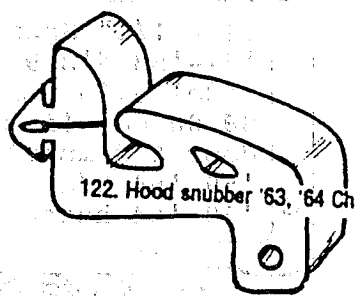

122. Hood snubber '63, '64 Chrysler

209. '63 Ply., Dodge hood snubber

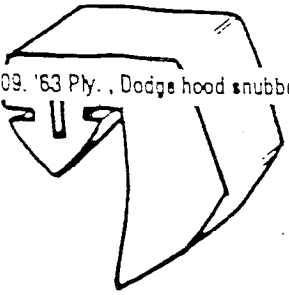

238. Hood snubber '65, '66 Imp.

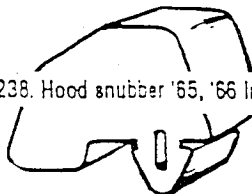

281. '65, '66 Dar, Val. Hood snubber

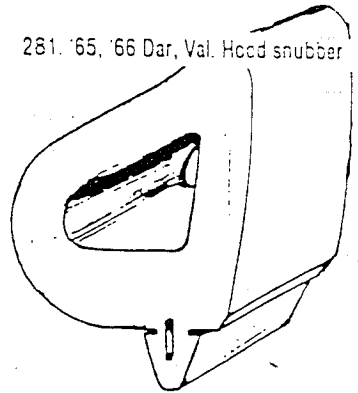

414
'64 Ply, Dod?
Hood snubber

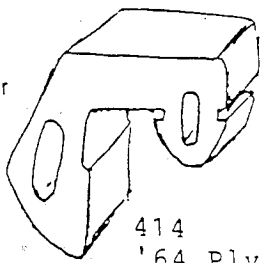

203. '65-'66 all hood snubber

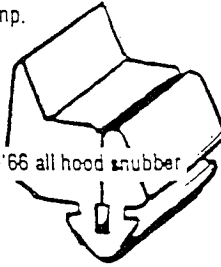

296. '66 Barracuda hood bumper

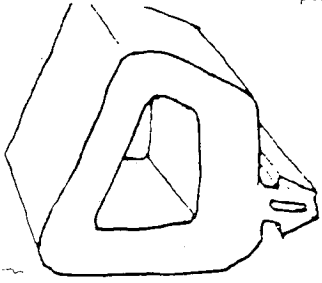

276 Hood snubber '67-'71 Dart, Valiant,
Duster

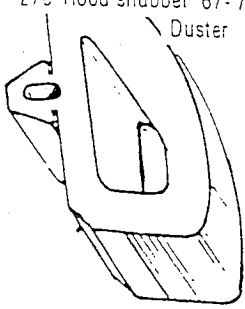

239. Hood snubber '67 up

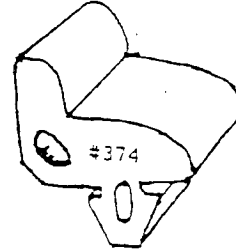
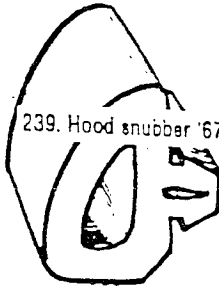

#374 '70-'74 Challenger
hood bumper.

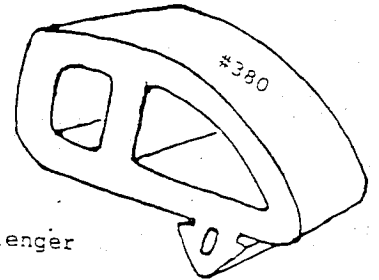

#380 '68 Imp. front
hood bumper

#372 '70-'74 Barracuda
hood bumper.

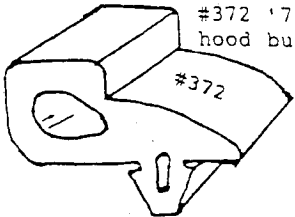

STARTER RELAYS

STARTER RELAYS

STARTER RELAYS

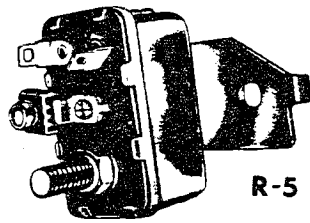

'67-'68 \$14.70

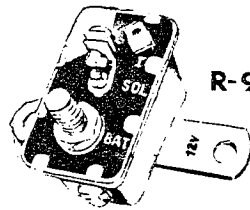

'61-'65 \$18.45

**OIL PRESSURE
SENDERS**

O-1



'53-'78 1/8 x 27
thread \$7.00

O-2



'62-'78 3/8x-18
thread \$7.60

O-3



'65-'82 \$22.60

O-4

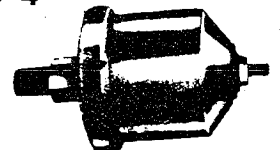

'60-'64 \$23.70

TEMP. SENDERS

T-1



'57-'60 1/4-18
thread \$11.25

R-1

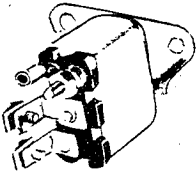

56-'57 \$13.80

R-2

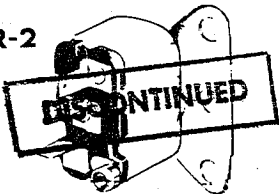

'58-'59 7.50

R-3



'60-'62 - Cars with
4 terminals use
'58-'59 relay

R-4

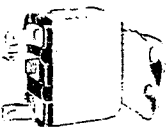

'63-'70 \$9.45

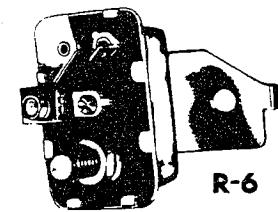

'67-'68 14.70

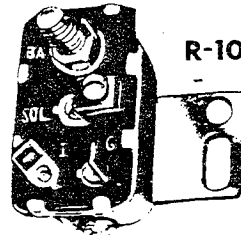

'65-'76 16.65

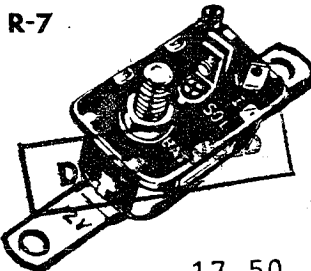

'56-'60 17.50

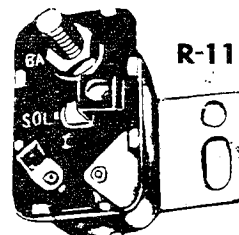

'65-'69 \$12.75

TEMP. SENDERS

T-2



'61-'68 1/8-27
thread \$11.25

T-3



'61-'82 1/8-27
thread \$11.25

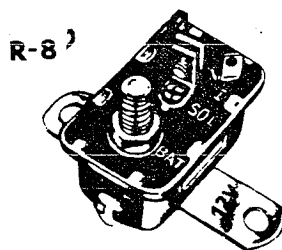

'61-'65 16.50

STARTER SOLENOIDS

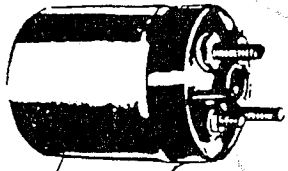

SO-1
'56-'59 \$51.20

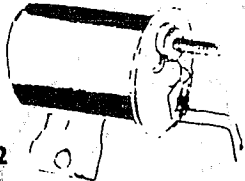

SO-2
'60-'63 \$38.00

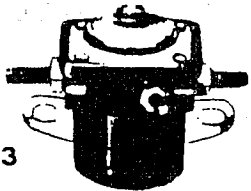

SO-3
Dodge & Plymouth
A. 6 volt \$21.40
B. 12 volt \$27.30

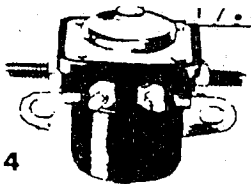

SO-4
'60-'61 \$24.60

DISTRIBUTOR LEADS

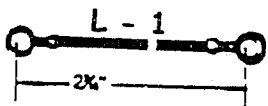

Older cars \$1.60

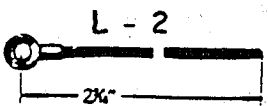

'51-'71 \$1.60

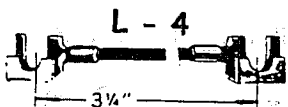

'51-'71 \$3.50

DISTRIBUTOR LEADS

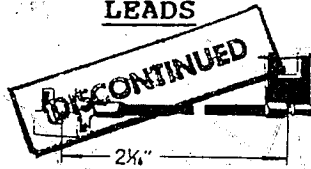

L-5 '56 2.00

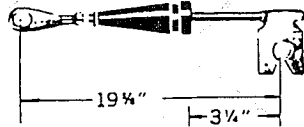

L-6 '61-'66 \$7.20

STARTER & GENERATOR BRUSH SETS

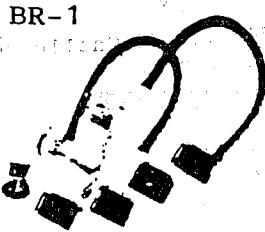

BR-1
Chrys. #2275249
'61-'82 starter \$11.50

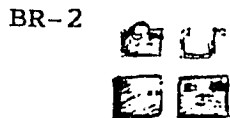

BR-2
Chrys. #1843135
'53-'68 starter \$6.00

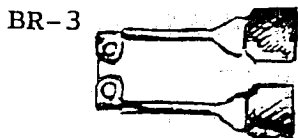

BR-3
A. Chrys. #1253367
'51-'58 gen. \$6.25
B. Presto. #GCD, GCE
2012S '56-'60 gen. \$6.25

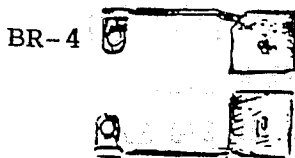

BR-4
Presto. #GJC-201-
2AS '56-'61 gen. \$6.20

DISCONTINUED
BRAKE LIGHT SWITCH

B-1
DISCONTINUED
LDS-2
STILL CALL
3/8" PIPE THREAD
ONLY A FEW LEFT
Most older cars
'60-'68 truck
\$6.50



B-2 '65-'82 \$5.10



B-3 '61-'66 \$6.20

NEUTRAL SWITCH



N-2
'57-'58 vacuum
sw. on intake
man. \$11.30



N-3
Neutral safety
sw. on trans.
'62-'68 \$8.00

VOLTAGE REGULATOR

'56-'60 \$32.00

RADIATOR (CORE) SUPPORT & COWL SEALS

RADIATOR (CORE) SUPPORT TO HOOD

102	'55-'65 Chrys. see Pg. #25	
W100	'56 Plymouth	\$16
W69	'63-'66 B-body	\$17
W81	'64-'65 A-body	\$19
W26B	'64-'65 Imperial	\$15
W70	'65 Fury, Polara	\$26
W82	'66 A-body	\$26
W69A	'66-'67 C-body	\$27
W68	'67-'69 A-body	\$24
W62A	'67-'71 B-body	\$23
W69C	'67-'68 Imperial	\$27
W69B	'68-'69 C-body	\$27
W61B	'70 A-body	\$24
W62B	'70-'71 C-body	\$23
W61A	'70-'74 E-body	\$24
W67	'72-'73 B-body	\$24
W92	'66 Imperial	\$26

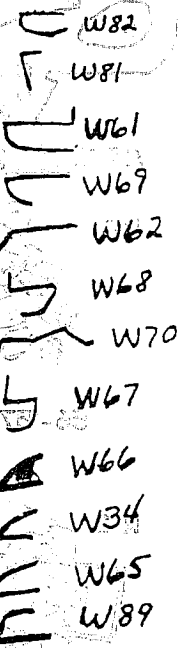

COWL-TO-HOOD

W71	'55 Chrys./Imp.	\$19
W71	'55-'56 DeSoto	\$19
W78	'56 Chrys./Imp.	\$18
W89	'56 Dodge/Ply.	\$18
W32	'57-'59 All exc Imp	\$18
W77	'57-'66 Imperial	\$23
W66A	'63-'66 A-body	\$18
W27	'60-'64 C-body	\$15
W66A	'62-'66 B-body	\$18
W66B	'65-'68 C-body	\$21
W64	'67-'75 A-body	\$19
W60	'67-'71 B-body	\$19
W66B	'67-'68 Imperial	\$21
W65	'69-'71 C-body	\$25
W34	'70-'74 E-body	\$21
W34	'72-'73 B-body	\$21

DRAWINGS NOT ACTUAL SIZE

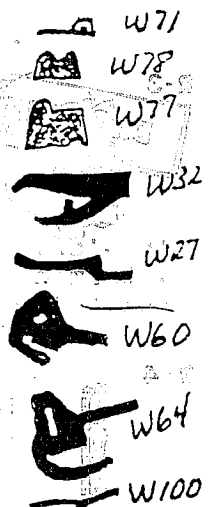

152. Clip Wire type clip for most hood-to-core support seals

SPLASH SHIELDS

102 -

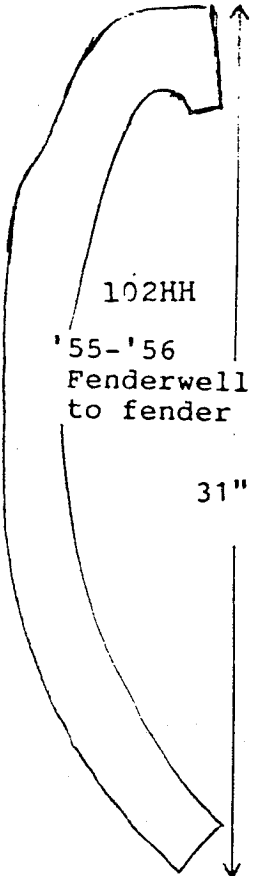

'55-'56 Fenderwell to fender R&L

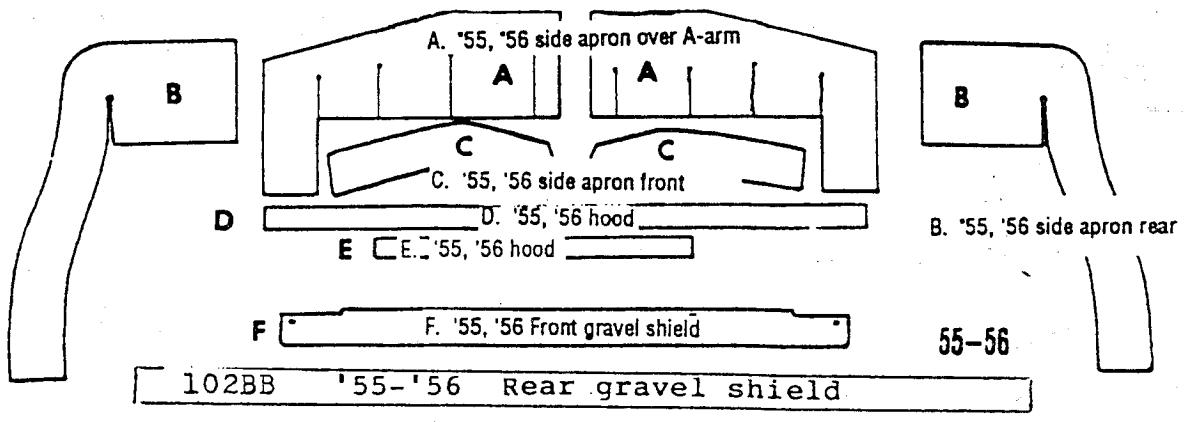

All splash shields are for Chrysler and DeSoto C-body unless labeled otherwise

W87 '55-'64 vertical seal between front fender and body. 2 ft long \$6.50

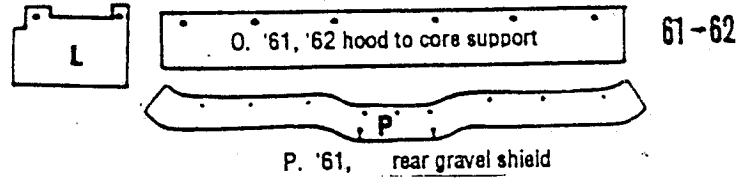
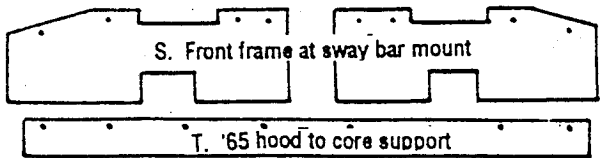
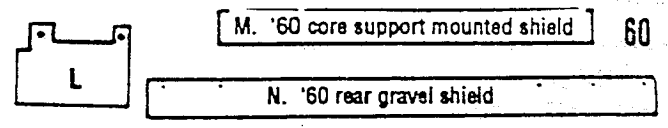
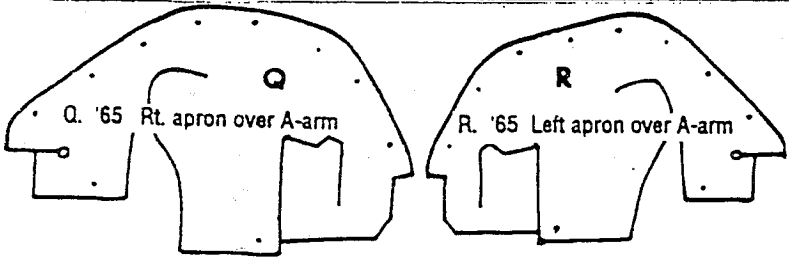
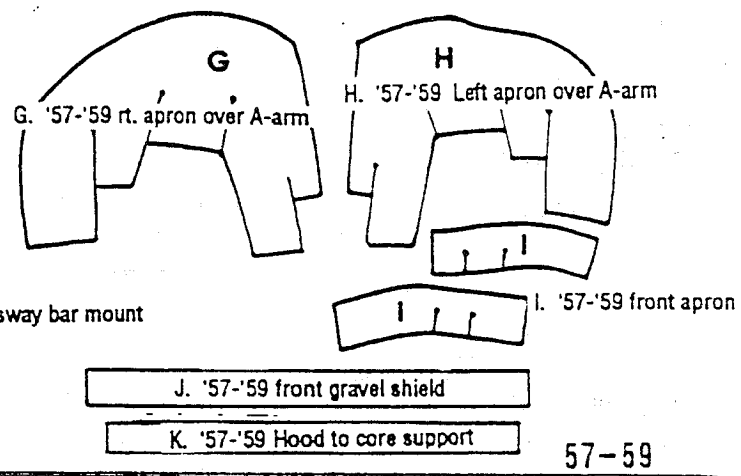

'66-'68 C-body almost the same as Q, R, S. Order Q, R, S and state year ('66-'68)

Most early cars used staples to fasten the splash shields. Heavy duty staples are included and must be installed one at a time by hand. Use an ice pick to punch holes.

Most '62 & newer splash shields take small wire type fasteners. These are not available, but were used for years on almost all cars. Check your wrecking yard.

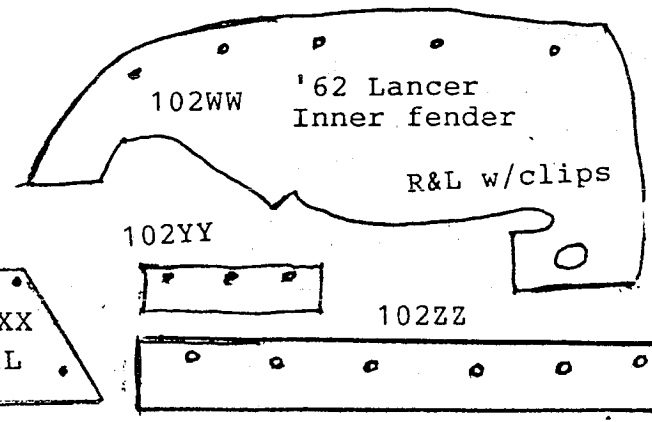

U. '63, '64 Rt. apron over A-arm

U

W. '63, '64 hood to core support

W

V. '63, '64 Lf. apron over A-arm

V

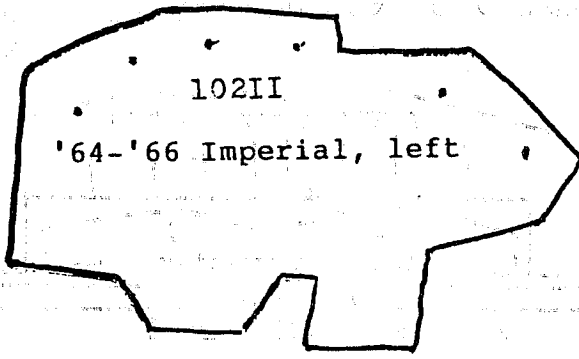

102II
'64-'66 Imperial, left

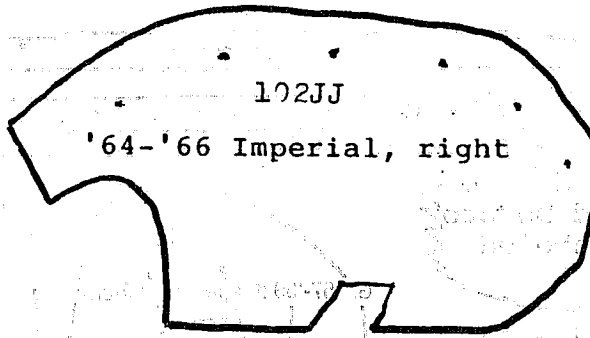

102JJ
'64-'66 Imperial, right

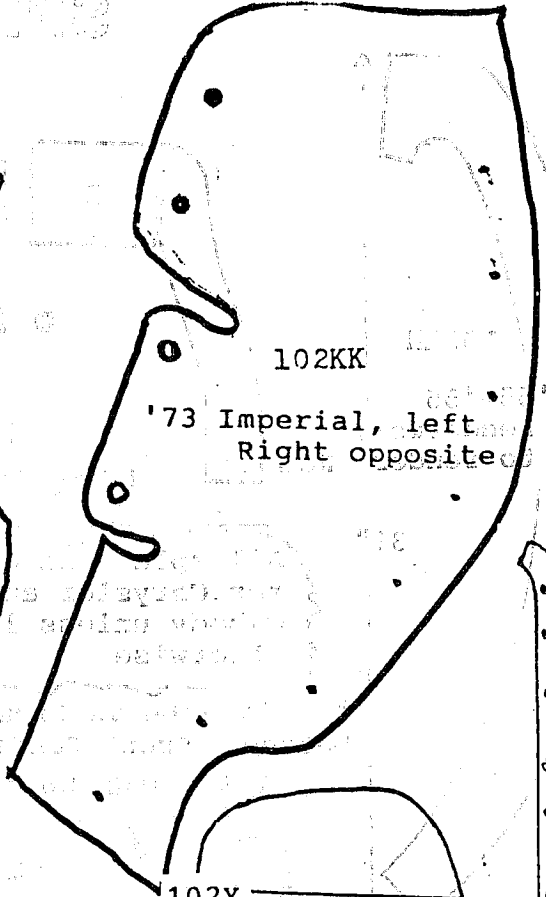

102KK
'73 Imperial, left
Right opposite

HOOD-TO-CORE-SUPPORT SEALS
ARE UNDER SEPARATE LISTING

63-64

102MM

Right

102Y

'57-'59 Plymouth
Dodge

102LL

102NN

102Z

'59 Plymouth rear
gravel shield

'56 Dodge, Plymouth

102PP

Left

102QQ

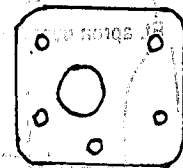

102AA

'57-'59 Dodge and
Plymouth steering
column base plate
gasket

10200

102RR '56 Dodge, Plymouth R&L opposites

102X

'61-'63 Imperial hood

102CC

'59 Imperial rear of
inner fenderwell R&L

102EE

R&L

'70 Chrysler

102GG

R&L

102FF R&L

102DD

'59-'63 Imperial over
A-arm R&L

(Probably fits '69-'71
Chrysler and Imperial)

#W135

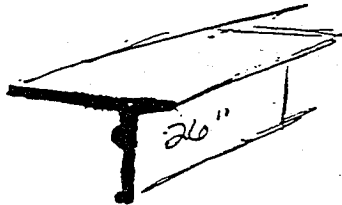

"T" rubber seal between inner splash panel & front fender. Most A & B bodies. Use #430 plastic clips. 26" length. \$12.00

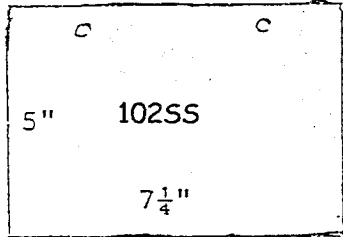

'63-'65 A-body

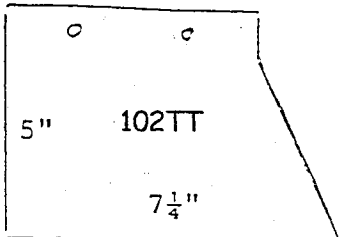

'66 A-body

Splash shield on outer front frame rail at bumper bracket mounting point.

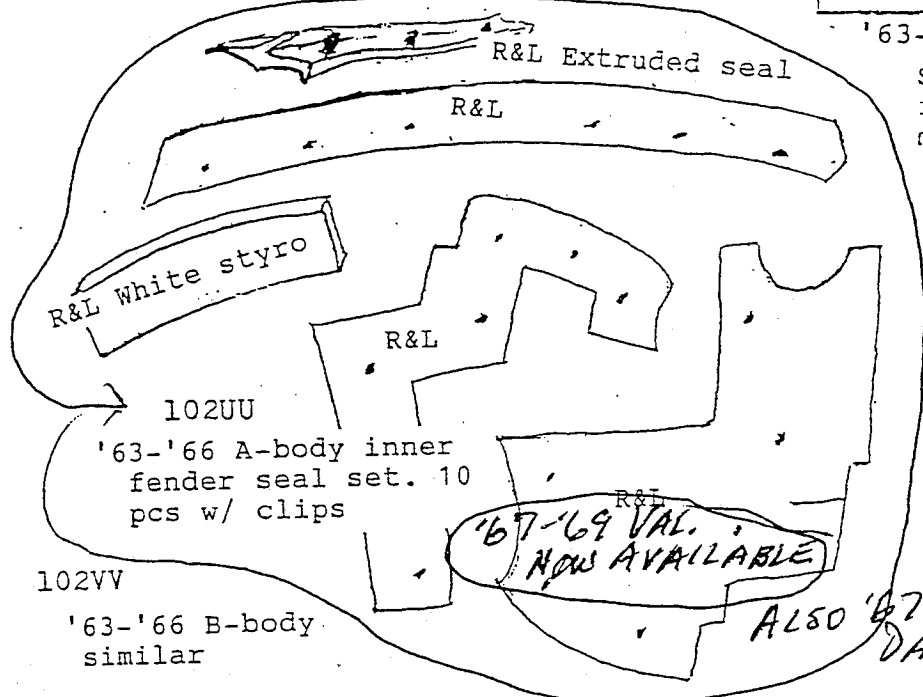

R&L White styro

102UU

'63-'66 A-body inner fender seal set. 10 pcs w/ clips

102VV

'63-'66 B-body similar

'67-'69 VAL. NOW AVAILABLE

ALSO '67-'69 DART

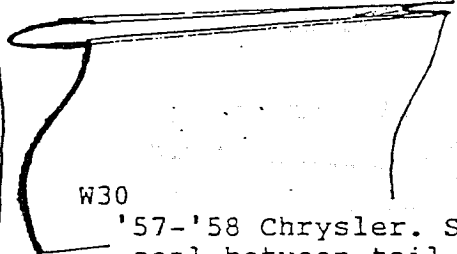

W30

'57-'58 Chrysler. Special seal between tail light filler and bumper \$8.90pr

DRAWINGS NOT

ACTUAL SIZE

BODY - PLUGS & MISC.

FRONT AND REAR BUMPER SHIELDS

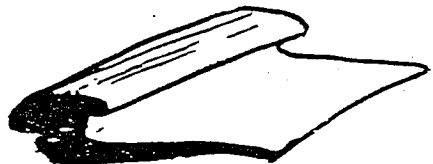

W112 '50 Ply. shield under rear bumper \$36.00

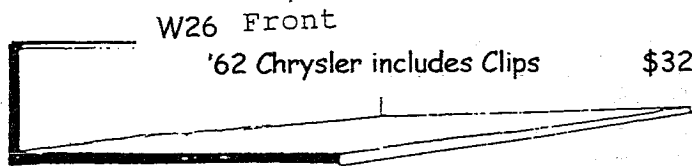

W26 Front '62 Chrysler includes Clips \$32.00

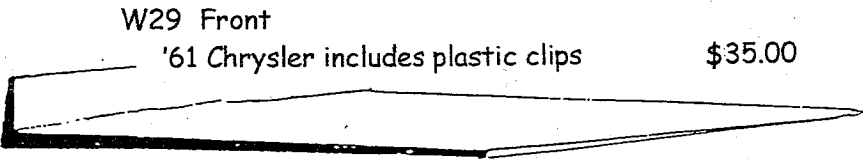

W29 Front '61 Chrysler includes plastic clips \$35.00

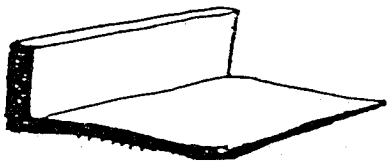

W113 '63-'65 Belvedere, Sat. shield under rear bumper \$32.00

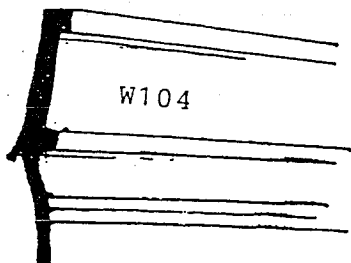

W104 shield under rear bumper '66-'67 Charger & others 75" strip \$36.00

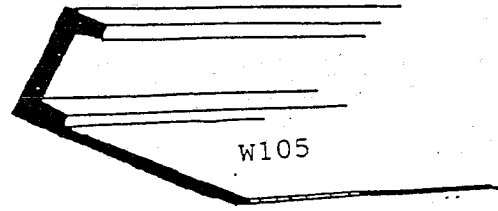

W105 Shield under rear bumper '70 B-body '65 Chrys '74 strip \$32.00

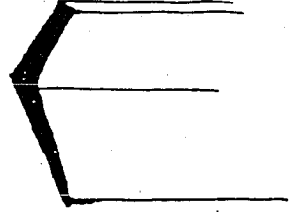

W114 '69 Ply. Roadrunner shield under rear bumper \$32.00

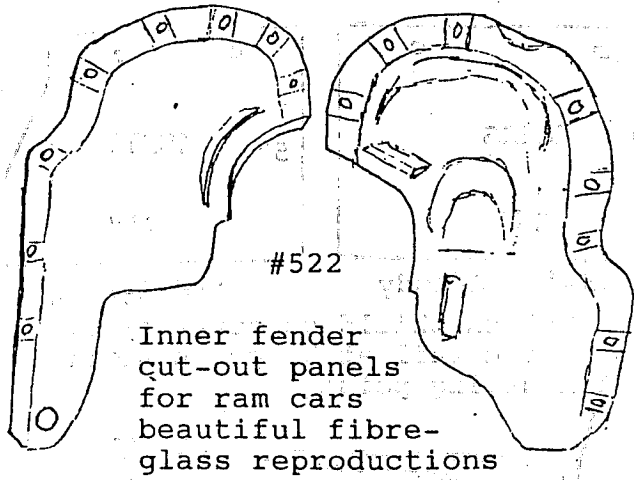

#522
Inner fender
cut-out panels
for ram cars
beautiful fibre-
glass reproductions

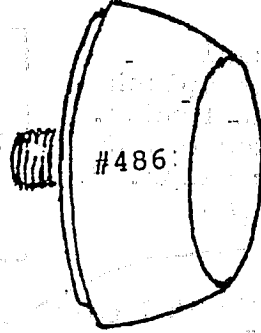

#486
'59 Desoto
fr. bumper
cushion

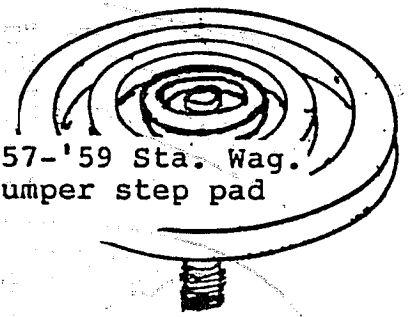

#476 '57-'59 Sta. Wag.
rear bumper step pad

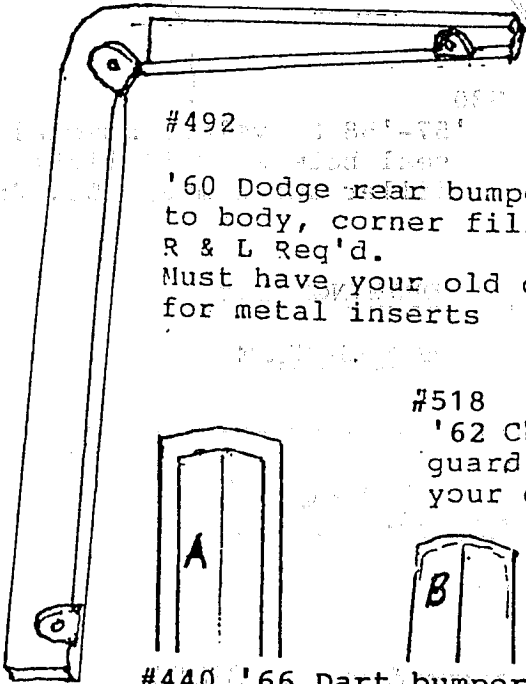

#492
'60 Dodge rear bumper
to body, corner fillers
R & L Req'd.
Must have your old ones
for metal inserts

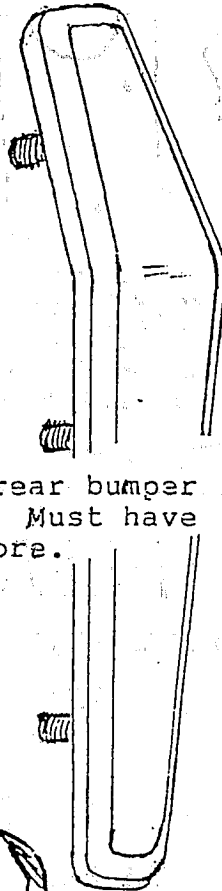

#518
'62 Chrys rear bumper
guard pad. Must have
your old core.

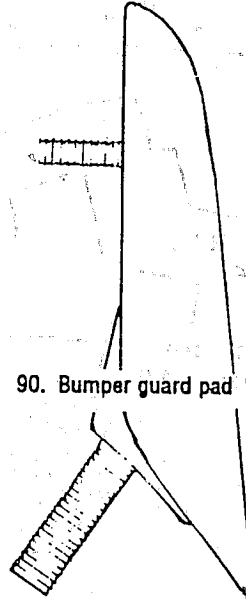

90. Bumper guard pad '60, '61 Exch.

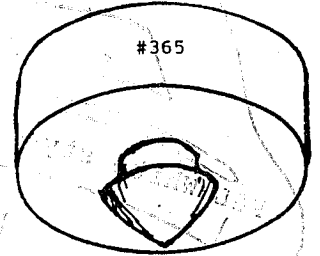

#365
'57-'59 trunk
floor to frame bumper.

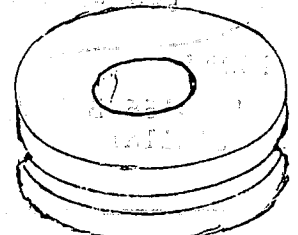

187. Rear transmount
'62 Chrysler

40. Rear spring clamp insulator '55-'65

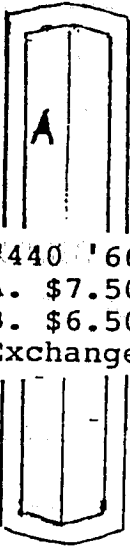
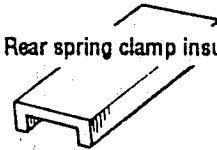

#440 '66 Dart bumper pads
A. \$7.50
B. \$6.50
Exchange

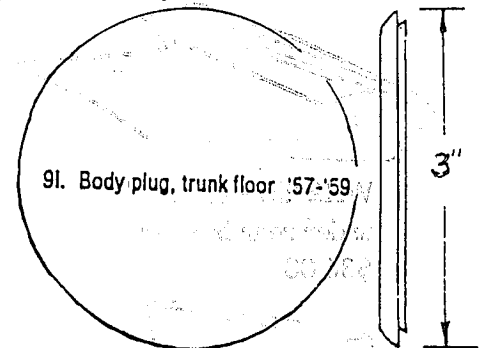
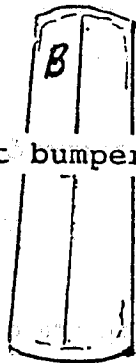

91. Body plug, trunk floor '57-'59

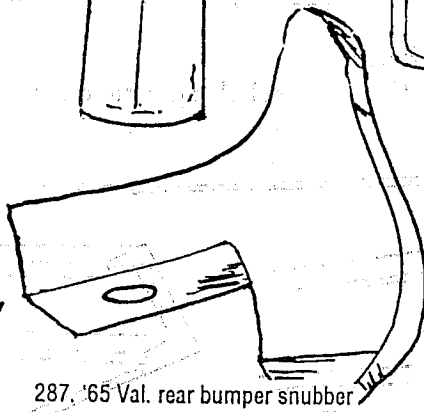

287. '65 Val. rear bumper snubber
(bolts to quarter panel)

113. cowl vent door seal '55-'66
(4" extruded strip)

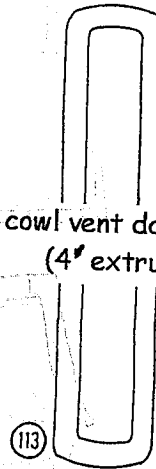

190
Sheet metal plug,
black plastic

- A. 1/2"
- B. 3/4"
- C. 7/8"
- D. flush 1"
- D. recess 1"
- E. 1-1/4"
- F. 1-1/2"
- G. 1-3/4"
- H. 1-7/8"
- I. 2"
- J. 2-1/2"

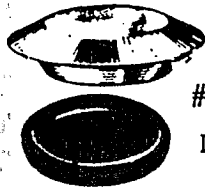

A-D
#190
D-J

156. Rubber Body Plug
A. 2 1/4" hole
B. 1 7/8" hole

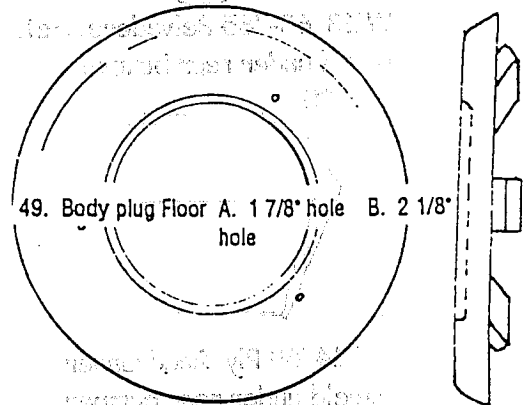

49. Body plug Floor A. 1 7/8" hole B. 2 1/8" hole

- #339A Molded body mounts '55 & later
- #339B Tall center (fits into 339A)
- #339C Short center

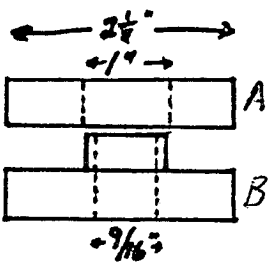

#294 Rubber body mount pads. A. 1/2" thick
B. 1/8" thick to shim A if necessary

352A '68 Chrys. Body to bumper corner fillers R&L

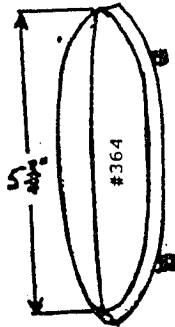
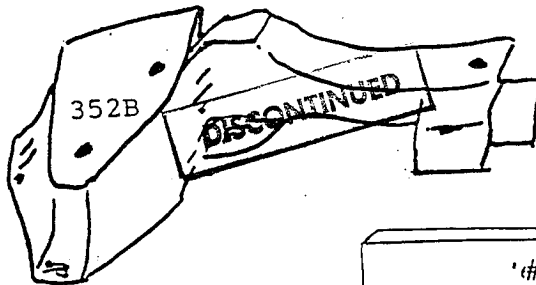

#364 '65 Plymouth rear bumper guard pad. (EXCHANGE)

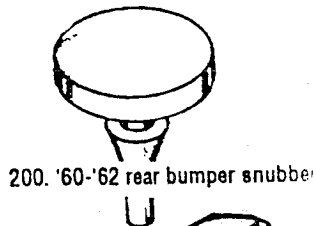

200. '60-'62 rear bumper snubber

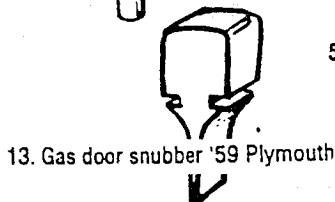

13. Gas door snubber '59 Plymouth

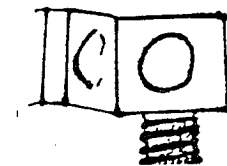

279. Special snap-in stud for rear bumper '57-'58 Chrysler

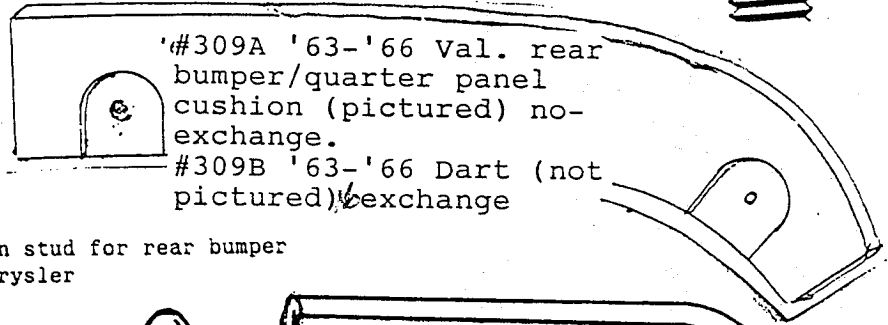

#309A '63-'66 Val. rear bumper/quarter panel cushion (pictured) no-exchange.
#309B '63-'66 Dart (not pictured) exchange

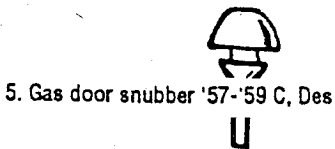

5. Gas door snubber '57-'59 C, Des

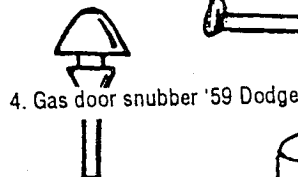

4. Gas door snubber '59 Dodge

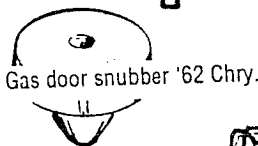

275. Gas door snubber '62 Chry.

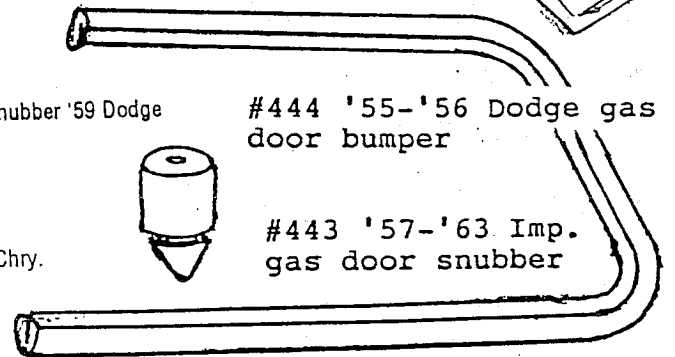

#444 '55-'56 Dodge gas door bumper



#443 '57-'63 Imp. gas door snubber

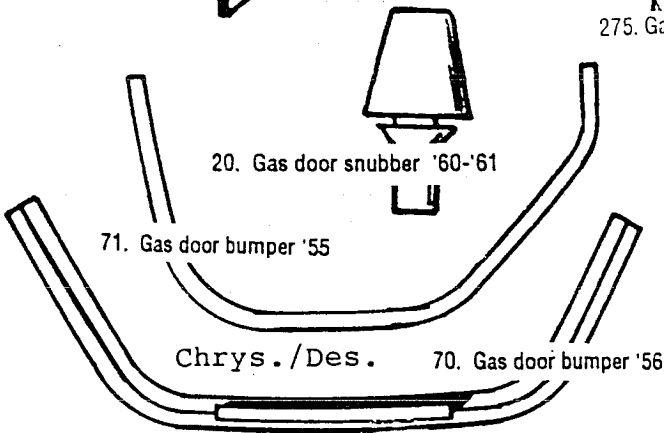

71. Gas door bumper '55

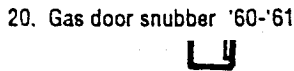

20. Gas door snubber '60-'61



70. Gas door bumper '56

Chrys./Des.



#491 '63-'65 A-body rear license plate mounting clip



#470 '63-'65 A-Body rear lic. plate snubber



33. License plate snubber '57-'65 front



10. License plate snubber '60 and up



9. License plate snubber '57-'58 rear

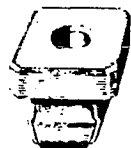

382 License plate nut Nylon-use with #383

383 License plate screw Use w/382 nut



#460 '57-'59 All Bumper & screw for rear corners of hood mounts on cowl. Dealer fix for rear of hood dropping below fender line. Set of 2

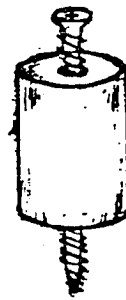

341 R&L pads between rear bumper & body '62 Chrys. (exchange only)

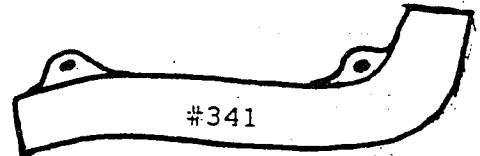

#140 Stainless steel capped bumper bolt
A. 1/2"-13x1-1/4"
B. 7/16"-14x1-1/4"
C. 3/8"-16x1"

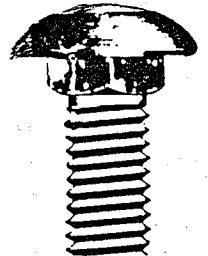

SOCKET & PIGTAIL ASSEMBLIES

P-1 \$2.10

Pigtail complete with terminal. Lamp #53, 55, 57, 1895

P-2 \$2.80

Pigtail complete with terminal. Lamp #67, 89, 93, 97, 1003, 1073, 1141, 1156

P-3 \$3.20

Pigtail with terminals for double contact base sockets. Lamp #1034, 1154, 1157, 1158, 1176, 1178

P-4 \$5.10

Single contact socket Lamp #67, 89, 93, 97, 1003, 1073, 1141, 1156

P-5 \$4.60

Single contact socket Lamp #53, 55, 57, 1895

P-6 \$4.80

Single contact socket, rubber covered. Lamp #53, 55, 57, 1895

P-7 \$5.70

Double contact socket. Lamp # 1034, 1154, 1157



#386 Nut headlamp door mtg plastic

#504 Free spinning washer nuts.
A. 1/4"-20
B. 5/16"-18
C. 3/8"-16
D. 10-24

398 '67-'70 Headlamp adj screw

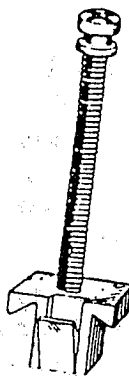

401 repl 152867 see 400 Headlamp door spacer



400 '68-'69 repl 6027014 Headlamp door spacer

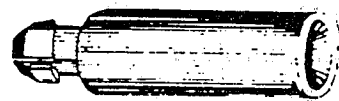

137. Hood letter clips '57-'59 Chrys. 300

185. Thread cutting nuts for stud sizes
A. 1/4" B. 1/8" C. 3/16" D. 5/32"



180. Tubular speed nut for stud sizes
A. 1/8" B. 3/32"

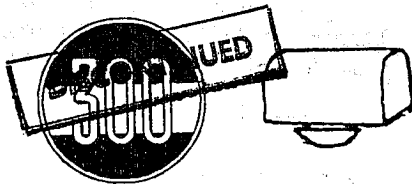

#139 Wheel cover snubber for '56 Plymouth



'62 300 side medallions reproduction, some flaws. Deal at \$50.00 Satisfaction or money back!

#178 Push on speed nut
A. 3/32" B. 1/8"
C. 1/16" D. 5/32"

FIBRE WIRE LOOM



307. Wire cover, A. 3/16" I.D.
B. 5/16" I.D.
C. 7/16" I.D. D. 1/2" I.D.



#345 Fuel tank support stud. 3/8"-16x4 1/2 '57-'62

#388 8-18x3/8" Phillips head (washer) screw--br zinc. Wheel opening mold etc.

UNIVERSAL MOULDING CLIPS

CLIP INSTALLATION NOTES

Curved edges of these universal clips allow installation in a wide range of stainless mouldings.

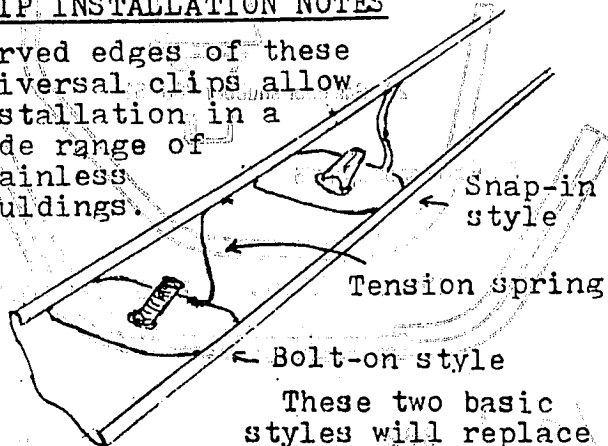
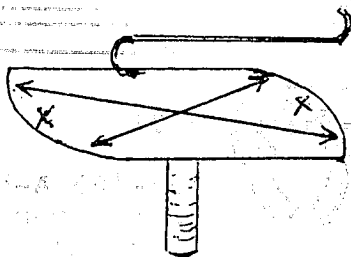

All clip illustrations are actual size. Simply measure between points shown by arrows to find size range. 'X'

These two basic styles will replace most original flat metal clips mounted on the body.

A12744
10-24X3/4

A12514
10-24X1/2

A12619
10-24X3/4

A12752
10-24X1/2

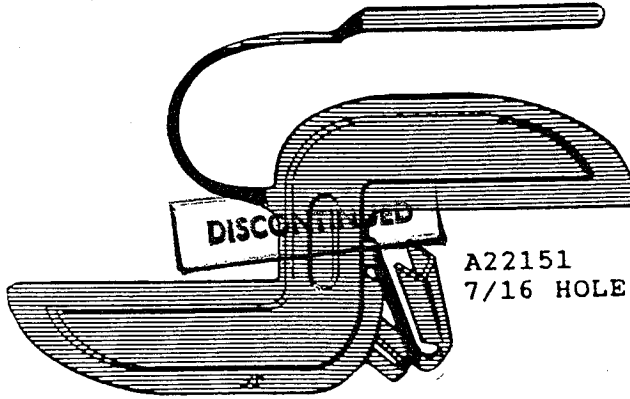

A22151
7/16 HOLE SIZE

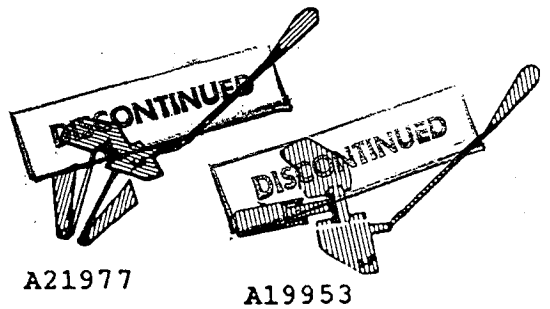

A21977

A19953

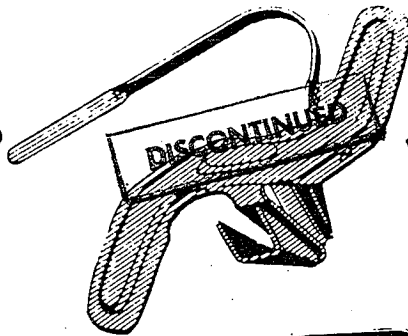

A12620

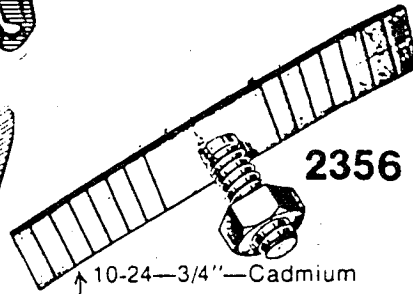

10-24-3/4"—Cadmium
Break off for correct size

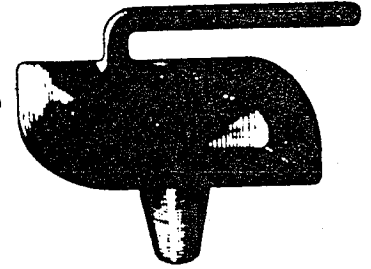

8400

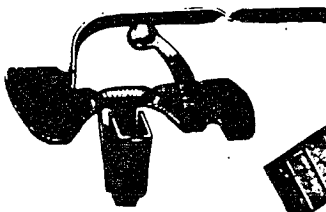
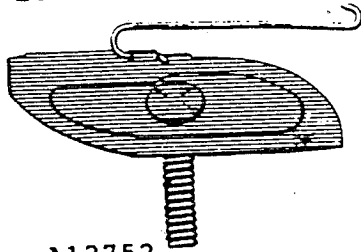

A12618

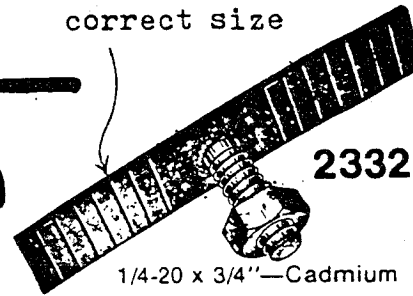

1/4-20 x 3/4"—Cadmium

Plastic snap-in style

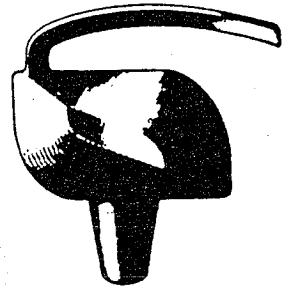

8386

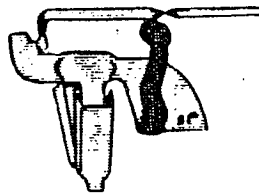
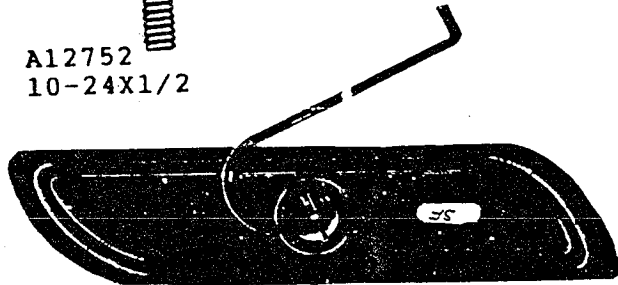

A12943

10794

Screw Size 10-24
Length 3/4"
PLATE Length 4-1/2"
W/SEALER

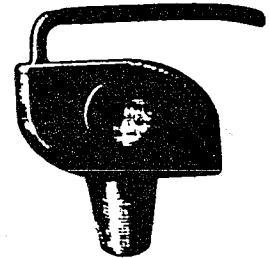

8399

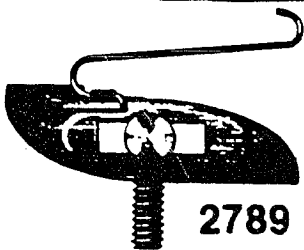

2789

A13164
10-24X1/2

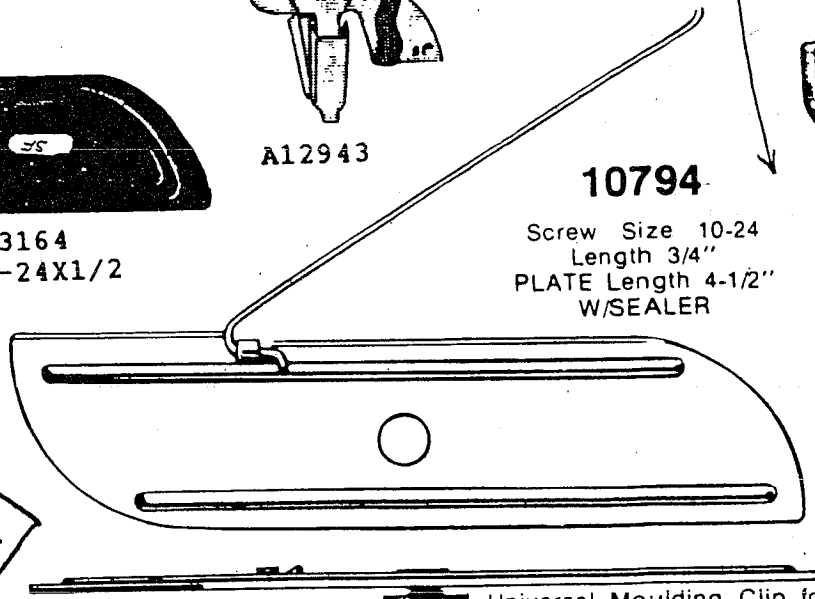

Universal Moulding Clip for 4" Moulding:

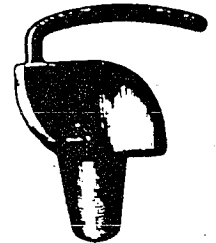

8398

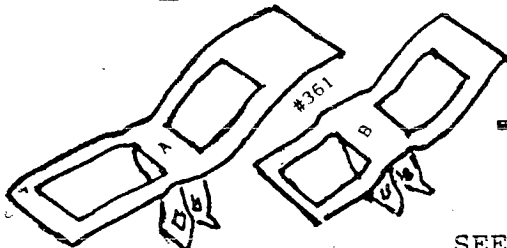

'60-'62 Lower windshield & backglass trim clips. good used

SEE INSTALLATION NOTES ON PRECEDING PAGE



WOW! CHECK THESE OUT! BEAUTIFUL RECREATIONS OF IMPOSSIBLE TO FIND SPECIALTY FASTENERS. Plated to resist corrosion. Some are ready now; the rest should be ready soon!!

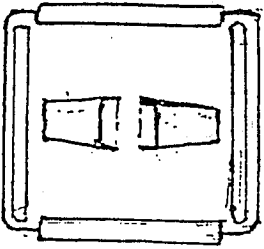

#495 '57-'59 300 side moulding clip. '57 Desoto

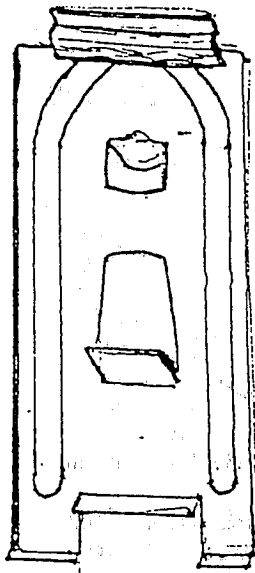

#497 '59 rocker moulding clip.

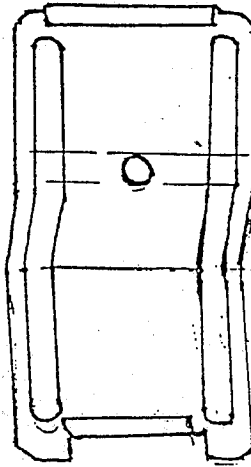

#498 '60-'64 rocker moulding clip.

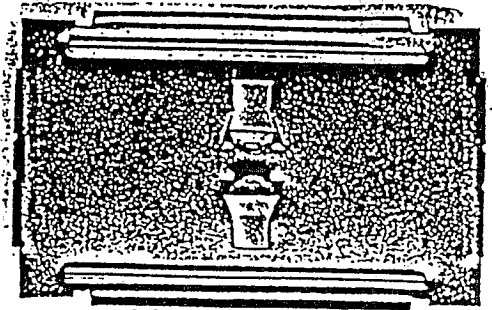

#499 '65-'66 rocker moulding clip. (KAE-01)

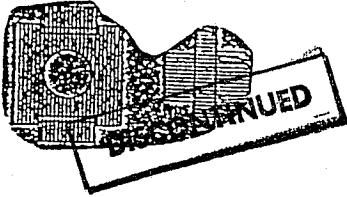

#503 '63 Dart side moulding fastener-nylon.

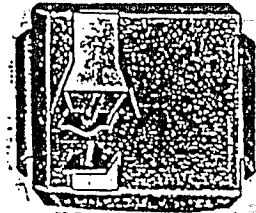

#500 -'56 300 side moulding clip.

115. Convert. top cylinder base bushing up to '59, all cars

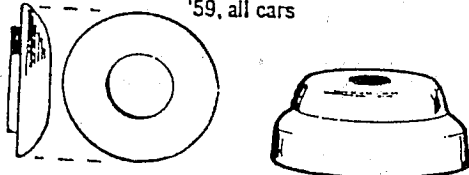

CONVERTIBLE ONLY PARTS

72. '60-'64 Convert. drain trough

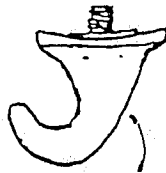

300. '58-'59 all conv. sun visor hook

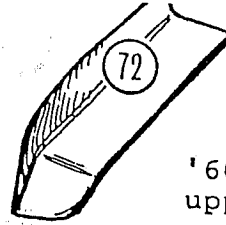

#528

'60-'63 Imp. cvt. upper windshield post seal (I think) R & L sponge with steel insert for mounting screw (actual size)

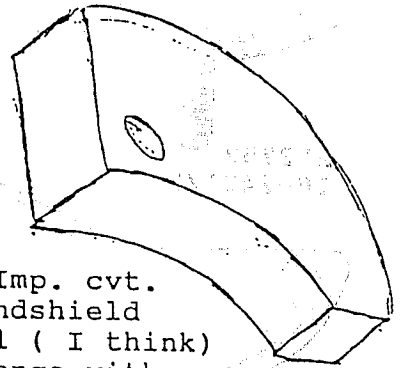

54. Convert. top header pin seal '57-'59

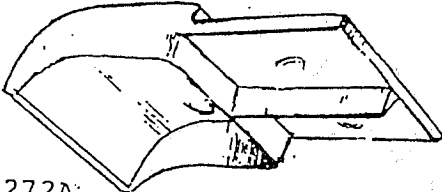

272A '41-'48 Plymouth Top-header-end seals. R&L

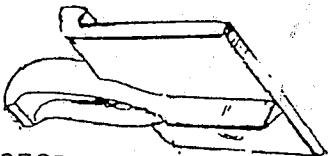

272B '39 Plymouth. Top-header-end seals. R&L

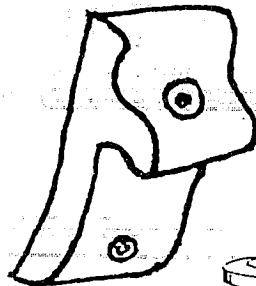

#389

'63-'66 A-body manual top catch (white)



146 Flathead Phillips Machine Screw
A. 12-24x1... '57-'59 conv. top latch hooks to w/shield frame
B. 1/4 - 20x5/8 anti-rattle unit to door frame

97. Convert top motor mount, all

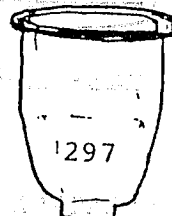
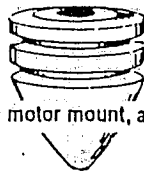

1297

'63-'68 A-&B-body some C-body Cvt-top pin well



#340 '57 Chrys., Desots conv. grommet for sunvisor end, goes in hole in header trim.

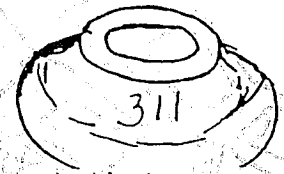

311 Grommet that presses on cvt top well drain from the back side to hold it in place. Generally for '63&up cars.

ROOF RAIL WEATHERSTRIPS FOR HARDTOPS

W128A	'65-'68 C-body 2 door hardtop with molded front tips.	\$65 set
W128B	'65-'68 C-body 4 door hardtop with molded front tips	\$65 set
W12C	'57-'59 Chrysler, DeSoto 2 door hardtop.	\$97 set
W12D	'57-'59 Dodge, Plymouth 2 door hardtop. Most '59 Dodges take W15 with #126 ends--see below.	\$97 set
W12E	'57-'59 all 4 door hardtops.	\$97 set
W35	'57-'59 Imperial 2dHT (top pieces only)	\$65set
W35/W36	'57-'59 Imperial 4drHT	\$80set
W13	Some '59-'64 All C-body. Used over rear glass on some '59-'62. Used on downward rear leg on '63-'64	\$3.80ft
W15	Some '59-'64 All C-body. Used over door glass on all models & over rear glass on some '60-'62.	\$3.80ft
W53	'60-'66 Imperial all HT	\$3.90ft
W53	'60-'66 A-body HT over door glass	\$3.90ft
W53	'61-'65 B-body HT over door glass	\$3.90ft
W53	'67-'68 Barracuda over door glass	\$3.90ft
W54	'60-'66 A-body HT over rear glass	\$3.90ft
W54	'61-'65 B-body HT over rear glass	\$3.90ft
W54	'67-'68 Barracuda over rear glass	\$3.90ft
W74	'65-'70 All on windshield post	\$4.10ft
W16	'67-'70 All 2dHT over door glass	\$3.80ft
W73	'67-'70 All 2dHT over rear glass	\$3.80ft
W16	'67-'70 All 4dHT	\$3.80ft

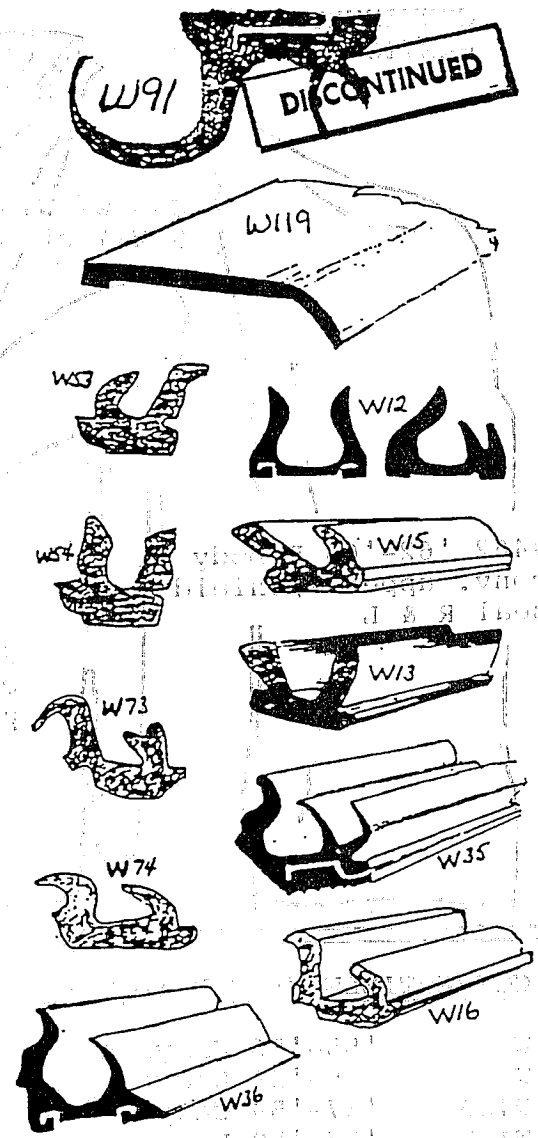

ROOFRAIL WEATHERSTRIP ENDS AND UPPER WINDSHIELD POST SEALS FOR HARDTOPS

* NEED OLD METAL CORES

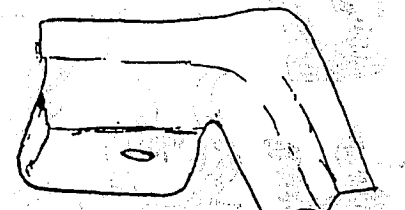
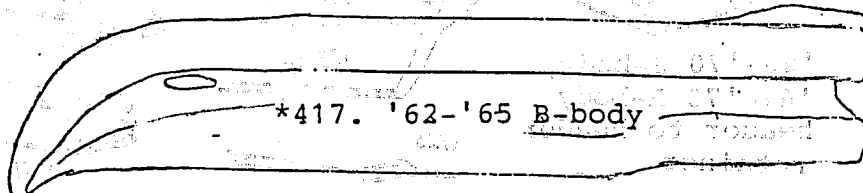
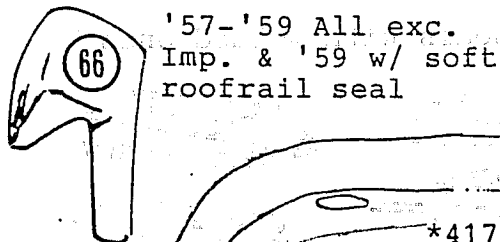
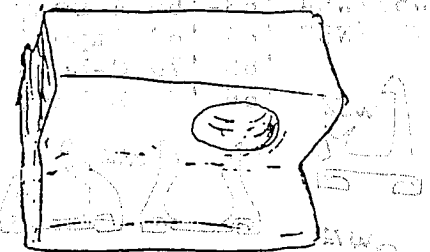
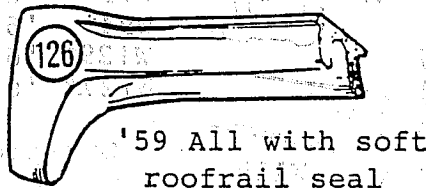
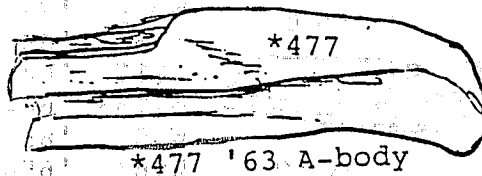
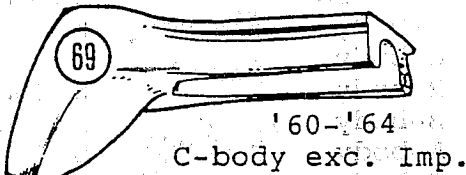
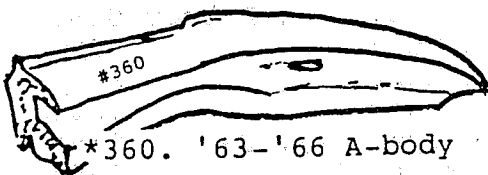

WINDSHIELD AND BACK GLASS RUBBER

The windshield and backglass seals listed below are extrusions -no molded corners. Unfortunately I've lost my manufacturer for these. Some are still in stock though. Good news is that I've begun the process of getting several applications made with molded corners. Bad news is that the projected delivery date is June, 2003. Not much of anything to do but wait. Initially '57-'62 windshield for all C-bodies and backglass for '57-'62 Chrysler/DeSoto are in the works. More to come!

WINDSHIELD SEALS

All are priced \$85 Enough for one windshield.

- W40 '55-'56 All with snap-in outer stainless top trim
- W37 '55-'56 All bottom
- W37 '55-'56 All top & bottom if no snap-in top trim
- W37 '57-'59 All top except Imperial
- W39 '57-'59 All bottom except Imperial
- W37 '57-'63 All Imperial
- W37 '60-'64 All C-body
- W44 '63-'66 A-body bottom except cvt
- W45 '63-'66 A-body top except cvt.
- W44 '63-'66 A-body cvt.
- W83 '64-'65 B-body top
- W84 '64-'65 B-body bottom
- W47 '68-'70 A-body
- W52 "Chrome" lockstrip for W44, W45 \$24.00each
- W123 '66-'68 C-body, '67-'68 Imp. top
- W124 '66-'68 C-body, '67-'68 Imp. bottom

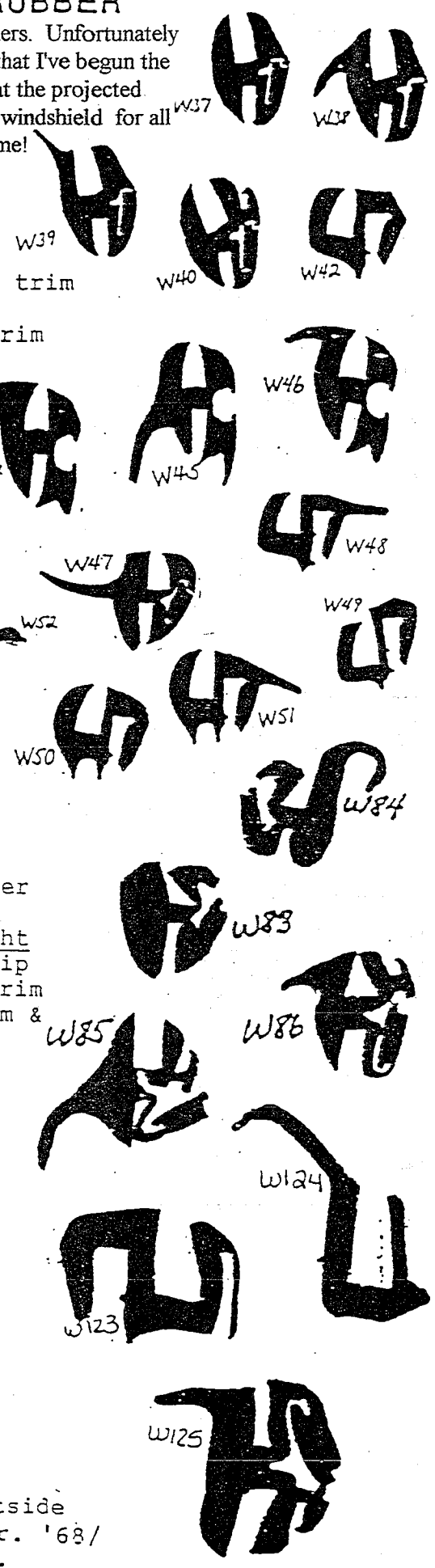

BACKGLASS SEALS

All are priced \$85. Enough for one backglass.

- W125 '55-'56 Dodge/Plymouth
- W40 '55-'56 All w/ inside metal trim & outer snapin trim, top and bottom
- W85 '55-'56 All w/o inside metal trim but, with outer snap-in trim, top and bottom
- W86 '55up All bottom w/ snap-in outer trim & straight rear edge of package shelf under weatherstrip lip
- W85 '57-'59 Top w/ snap-in outer trim & no inside trim
- W40 '57-'59 Chrys., Des. top with outer snap-in trim & inside trim
- W38 '57-'62 All bottom w/o snap-in outer trim
- W37 '60-'62 C-body top
- W28 '60-'66 Imperial Lebaron
- W50 '63-'64 Chrysler top
- W51 '63-'64 Chrysler bottom
- W45 '63 Dart, '63-'66 Val. HT & Sdn. top
- W46 '63 Dart, '63-'66 Val. HT & Sdn. bottom
- W42 '64-'66 Dart all bodies HT & Sdn. top
- W43 '64-'66 Dart all bodies HT & Sdn. bottom
- W48 '68-'69 A-body HT bottom
- W49 '68-'69 A-body HT top
- W52 "Chrome" lockstrip for W45, W46, W44, \$24each

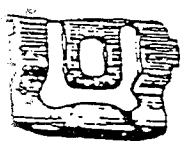

507. W/shield & rear window reveal mldg. clip. side & upper: Dodge, Ply., Dart '67, '68

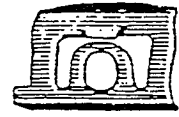

506. Windshield outside mldg. retainer. '68/ Chrys. prod.

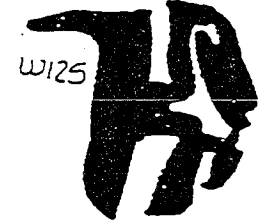

EVERSEAL GLASS SETTING TAPE

NEW! Super windshield and backglass seals. One piece high quality highly detailed seals with molded corners. All are priced \$90each.

Easy to install, this tape retains its strength and flexibility indefinitely. If a light oil is applied to it or the sidewalls of the channel, installation is made simpler and the tape will swell after setting and provide a permanent cushion for the glass.

All are for HTs. & Sdns unless otherwise noted.

WINDSHIELD SEALS

- WS103 '62-'63 Dodge/Ply. B-body
- WS102 '63-'66 Dart/Val. HTs, Sdns
- '64-'66 Barracuda
- WS100 '64 Belvedere, Fury, Savoy, Dodge 330/440, Polara/500,
- WS100 '65 Belevedere, Coronet, Satellite
- WS104* '66-'70 Dodge B-body Cvts, Plymouth B-body Cvts
- WS101 '68-'70 Belevedere, Charger, Coronet, Roadrunner, Satellite, Superbee
- WS101 '69 Daytona, '70 Superbird

Cat. #	Thickness	Width	Cost per Ft.
ES15116	1/16"	1-1/2"	.35¢
ES15132	1/32"	1-1/2"	.25¢
ES15332	3/32"	1-1/2"	.45¢
ES15364	3/64"	1-1/2"	.30¢

BACKGLASS SEALS

- WS102R '64-'66 Barracuda,
- WS100R '64-'65 Belevedere, Coronet, Dodge 2dHTs, Fury, Ply. 2dHTs, Polara, Satellite 2dHTs & Sdns.

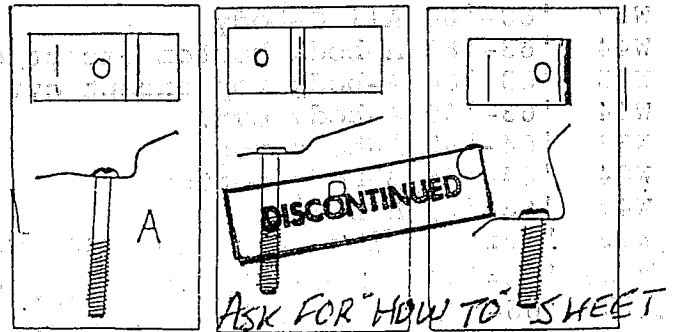

#490 '57-'59 all except Imp. windshield & backglass lower moulding fastener.
 A. windshield center 5 clips \$2.25ea
 B. windshield end clips (4) \$2.25ea.
 C. backlight; all 7 are the same \$2.25ea
 Complete set of 16 \$34.00

TOOLS AND SUPPLIES

GLASS POLISHING ASSEMBLY

Complete with 1/4" shank.

LT112
 A special handle and insert tool for installing self locking one piece rubber. Also excellent for installing rubber channels with a lip. Insert tool between the locking lip and its groove. Then, by moving the tool along the groove, the rubber lip locks in position.

\$21.50

64750
 Inserts the locking strip around windshields and other windows.

\$15.25

CRL216
 Plastic insert tool eases installation of glass into rubber channels and gaskets. Tapered ends slip in easily, and tool won't chip or scratch glass. Also good for tooling sealants.

\$1.50

KD2037
 One end of this tool spreads rubber zipper type gaskets. The other end removes "standard" Chrysler clips.

\$11.50

CP228
 Tool designed to speed closing of self-sealing windshield and back glass rubber.

\$13.25

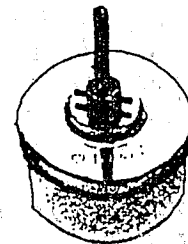

Made of highest quality white Spanish felt. 3 inch diameter by 1 1/2 inch thick. Wheel should be trued before each operation by gently running on medium grade sandpaper.

5703 \$28.50

CONTACT CEMENT

A high quality fast drying general trim adhesive used to glue leather, weatherstrips, vinyl, carpet etc.
 AD102A Quart \$6.70 AD102B Pint \$4.10

CERIUM OXIDE

High quality, optical grade polishing compound.

CO405 \$8.75

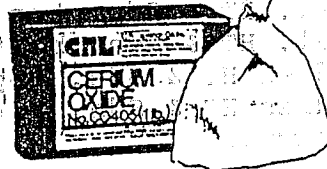

WINDSHIELD SEALER

An economical, non-hardening sealing compound used to seal glass installed in rubber. Standard caulking gun tube.

#447 '60-'64 Imp. Seal below corner of w/shield R & L

#446 '65-'66 Imp. Seal below corner of w/shield R & L

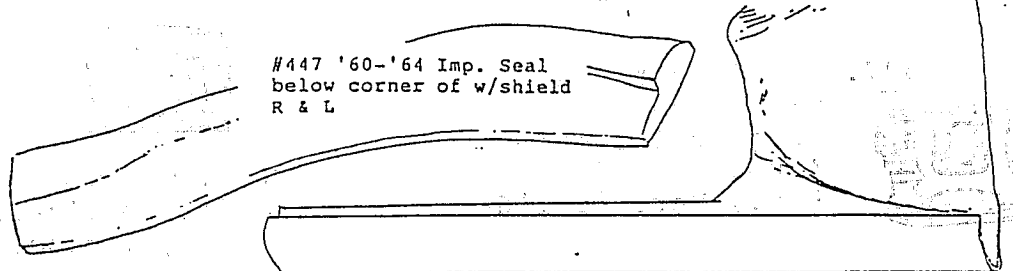

DECALS



226

226. 300 E valve cover



217. '57 & later P/S pump. Vinyl

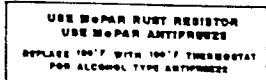

219. Core support. Vinyl

222. Fuel filter. '59 & later Vinyl.



232. Jack base sticker.

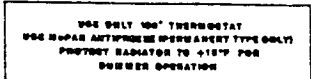

220. Cor support. Vinyl.



227. '58 & later Auto Pilot. Alum.

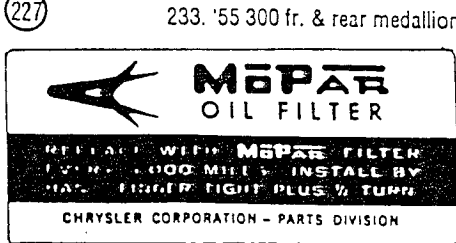

228. Spin-on filter. Paper.

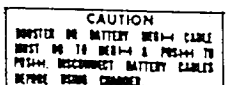

221. Core support Vinyl.

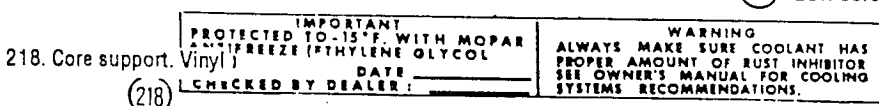

218. Core support. Vinyl

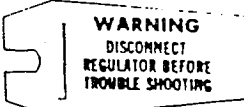

262. Red tag for all alternators

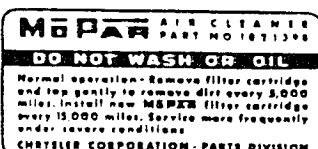

223. '57-'62 single, '57 dual water.

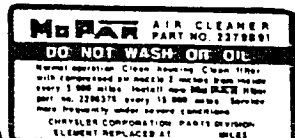

216. '63 & later single carb. Vinyl

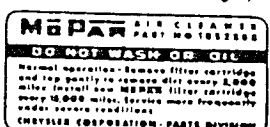
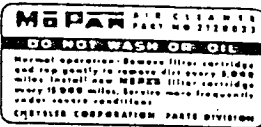

260. Back light decal all A/C cars

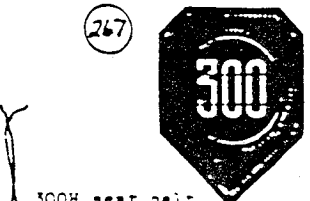

300H seat belt sticker \$3.00
3 color embossed foil

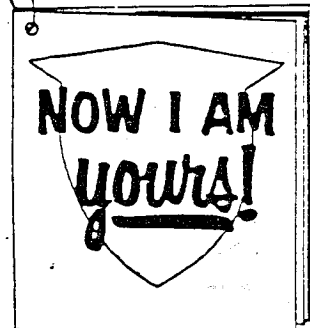

267. '56 Chrysler booklet

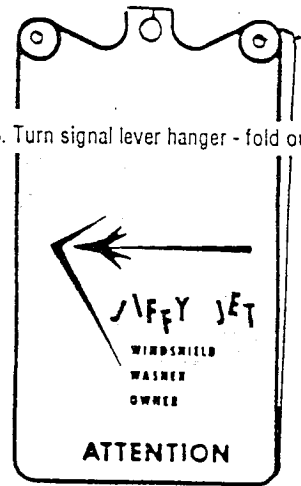

266. Turn signal lever hanger - fold out

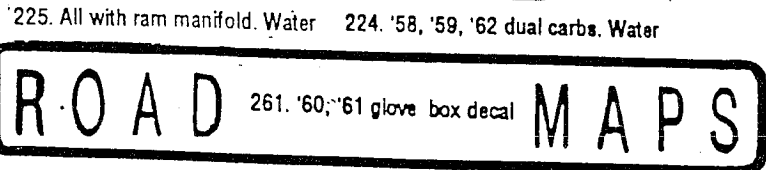

261. '60, '61 glove box decal

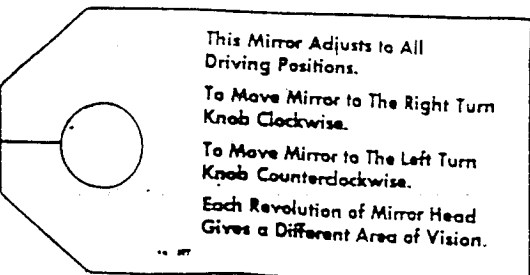

270. '58, '59 remote control mirror tag

229. Gen. field term. tag. Red paper

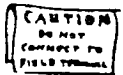

230. Reg. condensor wire tag. Red paper

231. Gen. condensor wire tag. Red paper

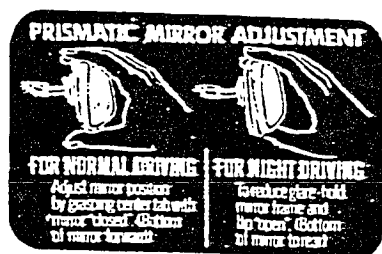

#332 Rear-view mirror sticker



265. Auto-Pilot hanger



335A. Golden Lion 383
335B. golden Lion 413

'59-'61 Chrysler valve cover decals

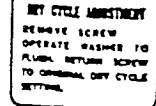

265. '60 windshield reservoir stickers

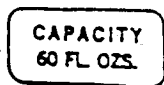

264

'59 Dodge valve cover decals
#533

WARNING

DO NOT SHORT ANY
TERMINALS TO GROUND

WARNING

033 2098300

#473 Decal for early
alternator voltage
regulators



D•500

GASKETS etc.

PICTURED ABOUT 10%
SMALLER THAN
ACTUAL SIZE

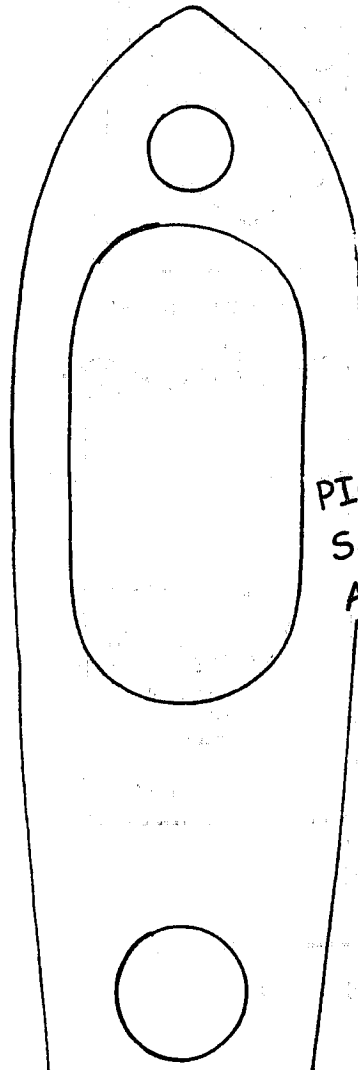

291. '57-'59 Dodge rear antenna
base gasket

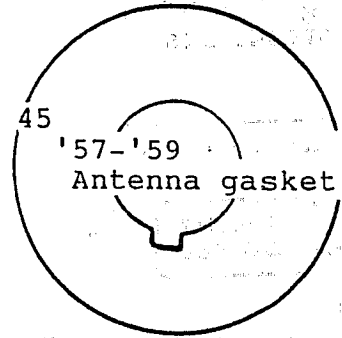

45
'57-'59
Antenna gasket

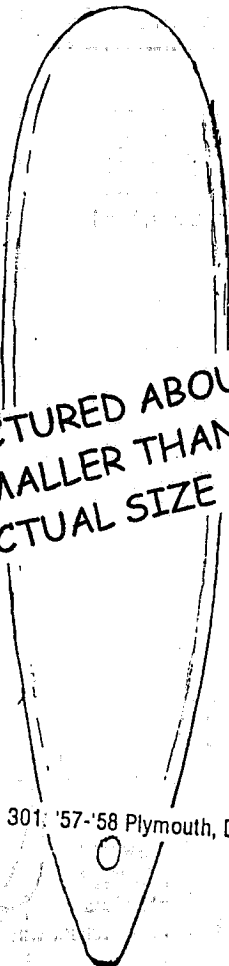

301. '57-'58 Plymouth, Dodge mirror gasket

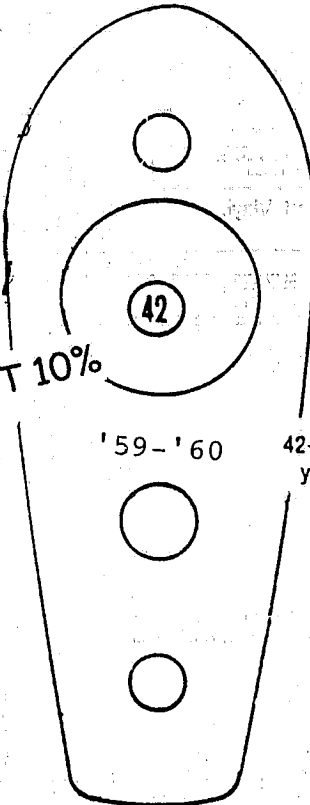

'59-'60

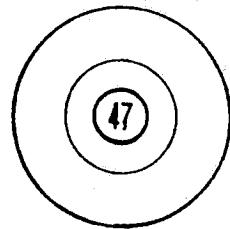

47

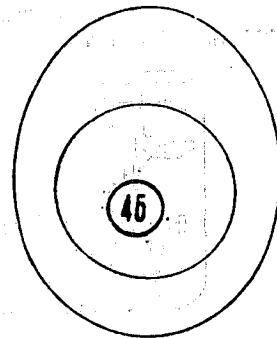

45

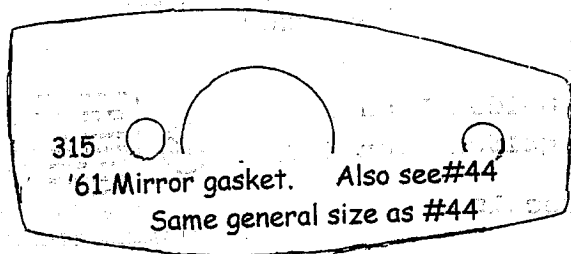

315
'61 Mirror gasket. Also see #44
Same general size as #44

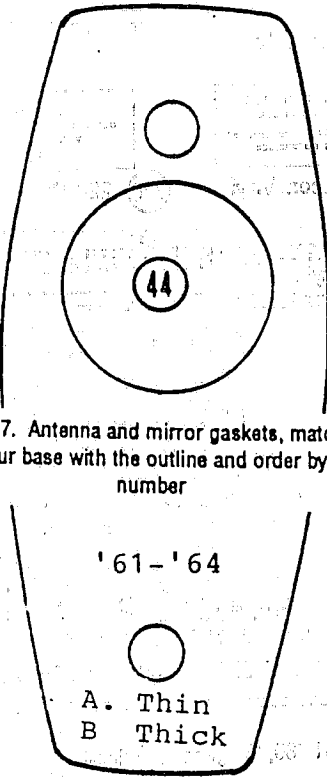

'61-'64

A. Thin
B. Thick

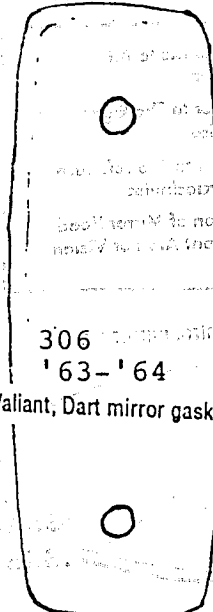

306
'63-'64

Valiant, Dart mirror gasket

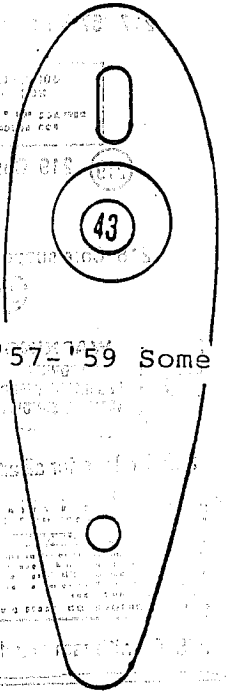

43

'57-'59 Some

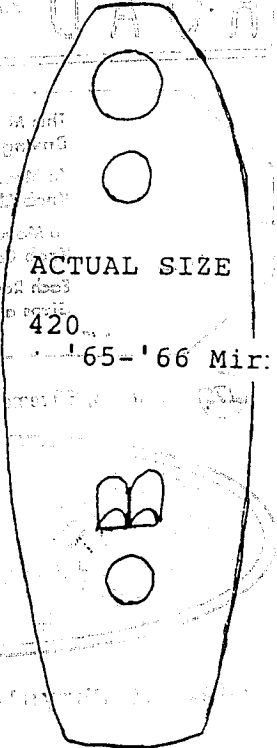

ACTUAL SIZE

420

'65-'66 Mir:

REMOTE MIRROR & ANTENNA GROMMETS

#94B New! repro plastic base (dotted line)

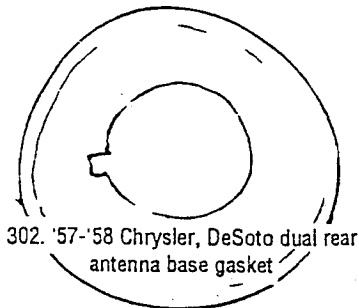

302. '57-'58 Chrysler, DeSoto dual rear antenna base gasket



313 '56 Dual rear antenna gasket

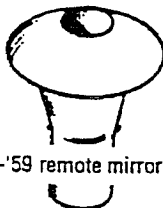

205. '58-'59 remote mirror grommet

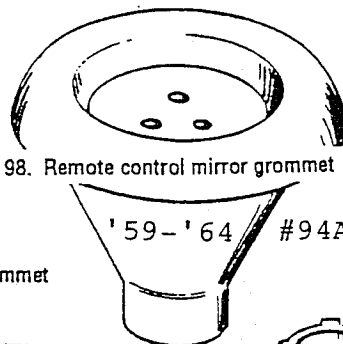

98. Remote control mirror grommet '59-'64

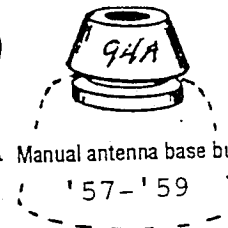

#94A Manual antenna base bushing '57-'59

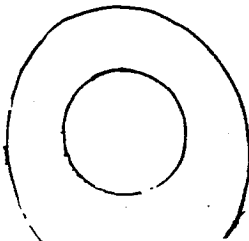

288. '55 Antenna base gasket.

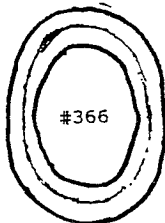

#366 '61-'63 Imp. headlight rear stanchion

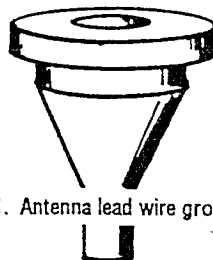

51. Antenna lead wire grommet '57-'59

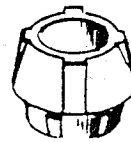

96. Antenna lead wire grommet '55, '56

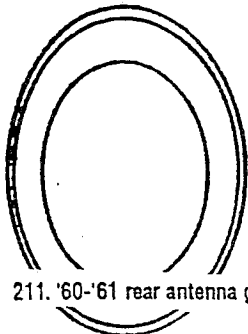

211. '60-'61 rear antenna gasket

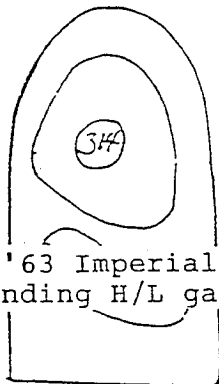

314 '61-'63 Imperial Standing H/L gasket

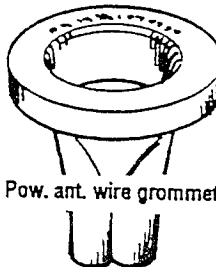

235. Pow. ant. wire grommet '57-'59



234. Man. antenna wire grommet '65

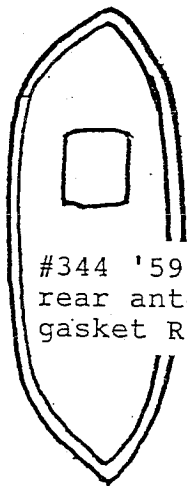

#344 '59 Desoto rear antenna base gasket R & L



W131 Rubber edging for '64 Dart, Dodge, Chrys. taillight housings and other applications. \$1.50/ft

'62 Chrysler T/L housing seal (Rubber on edge of chrome housing)

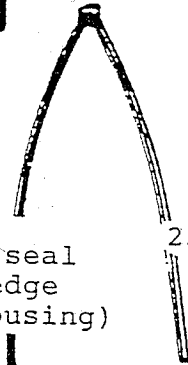

258

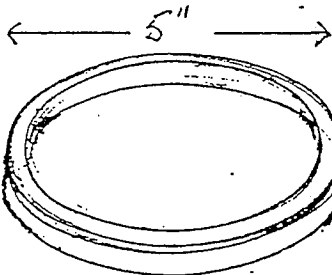

#465 '59 Dodge taillight housing to body seal. (Rubber seal on outer edge)

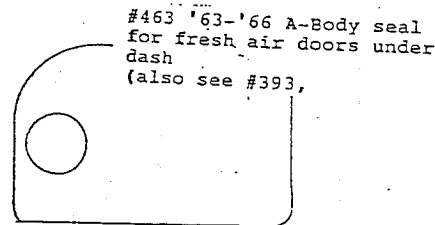

#463 '63-'66 A-Body seal for fresh air doors under dash (also see #393,

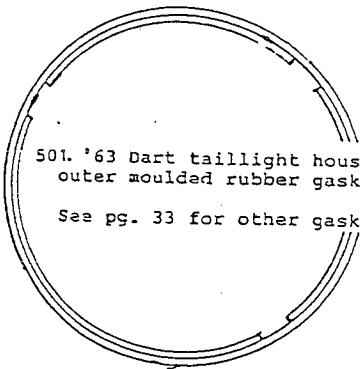

501. '63 Dart taillight housing outer moulded rubber gasket. See pg. 33 for other gaskets.

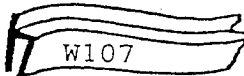

Rubber edging general use- see #W106 \$1.80/ft

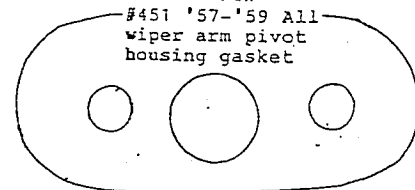

#451 '57-'59 All wiper arm pivot housing gasket

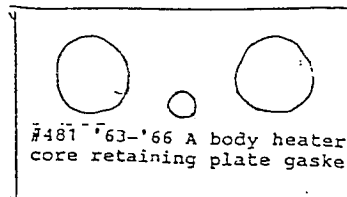

#481 '63-'66 A body heater core retaining plate gasket

LENS AND HOUSING GASKETS

Tired of cutting out strips of cheap junk to seal your lenses? Here's the cure! Die cut gaskets made from high quality gray sponge neoprene. This 3/16" material fits, seals and lasts.

TAIL LIGHT LENS GASKETS

TG28	'50 DeSoto	\$2.50
TG1	'55 Chrysler	\$3.00
TG29	'56 DeSoto	\$3.50
TG30	'56 Plymouth	\$3.00
TG3	'57 Chrysler	\$3.50
TG25	'57-'58 DeSoto	\$1.65
6 needed including backup lens		
TG36	'57-'59 Imperial	\$2.50
TG4	'58 Chrysler	\$3.50
TG32	'58 Dodge	\$2.50
TG10	'58 Plymouth	\$2.50
TG5	'59 Chrysler	\$2.50
TG38	'59 DeSoto	\$2.50
6 needed including backup lens		
TG39	'59 Dodge	\$3.00
TG11	'59 Plymouth 3 lens	\$3.50
TG6	'60 Chrysler	\$3.50
TG16	'60 Dodge	\$3.00
TG7	'61 Chrysler	\$4.00
TG34	'61 Imperial front	\$2.50
TG35	'61 Imperial rear	\$2.50
TG8	'62 Chrysler	\$3.50
TG37	'62 Imperial	\$2.50
TG33	'62 Plymouth	\$2.50
TG12A	'63 Dart inner	\$2.50
TG12B	'63 Dart outer	\$1.90
TG17	'64 Chrysler	\$2.75
TG9	'64-'65 Barracuda	\$2.75
TG31	'64 Dodge B-body	\$3.00
TG13	'64 Dart	\$2.50
TG14	'65-'66 Dart	\$2.50
TG9	'65 Valiant	\$2.50
TG15	'66 Valiant	\$2.50
TG27	'66 Valiant reflector	\$2.00
TG18	'68 Charger	\$2.50
TG23	'68 Dart	\$2.80
TG21	'68 Satellite	\$3.25
TG24	'69 Coronet	\$3.00
TG22	'69 Road Runner	\$3.50
TG20	'70 Charger	\$3.00
TG19	'70 Coronet	\$3.00

PARKING LIGHT LENS GASKETS

PG1	'55-'56 Chrysler 300	\$2.50
PG9	'55-'56 Imperial	\$2.50
PG30	'56 Chrysler New Yorker	\$2.50
PG2	'57 Chrysler	\$2.50
PG5	'57 DeSoto	\$2.50
PG2	'58-'59 Chrysler 300	\$2.50
PG33	'58 Dodge	\$2.60
PG10	'58 Plymouth	\$2.50
PG34	'59 Chrysler New Yorker	\$2.25
PG6	'59 DeSoto	\$2.50
PG27	'59 Imperial	\$2.50
PG3	'60 Chrysler	\$2.50
PG29	'60 DeSoto	\$2.50
PG7	'60 Dodge	\$2.50
PG4	'61-'62 Chrysler	\$2.60
PG28	'61-'62 Chrysler housing	\$2.00
PG4	'61 DeSoto	\$2.50
PG32	'62 Plymouth	\$2.50
PG11	'63-'64 Chrysler	\$2.50
PG14	'63-'64 Dart	\$2.00
PG15	'63-'64 Dart housing	\$1.75
PG11	'63 Plymouth	\$2.50
PG16	'65 Dart	\$2.50
PG8	'65 Valiant	\$2.50
PG17	'66 Dart	\$2.75
PG13	'66 Valiant	\$2.50
PG22	'68 Dart	\$2.50
PG18	'68 Satellite	\$2.50
PG24	'69 Chrysler	\$2.50
PG20	'69 Barracuda	\$2.50
PG23	'69 Dart	\$2.50
PG18	'69 Road Runner	\$2.50
PG26	'70 Challenger	\$2.50
PG21	'70 Coronet	\$2.50
PG19	'70-'72 Duster	\$2.50
PG25	'73-'74 Duster	\$2.50

LICENSE LIGHT GASKETS

LG1	'57-'58 Chrysler	\$2.50
LG1	'57-'58 DeSoto	\$2.50
LG5	'57-'58 Imperial	\$2.50
LG2	'59 All makes exc. Imperial	\$2.50
LG3	'60-'62 Chrysler	\$2.50
LG3	'60-'61 DeSoto	\$2.50
LG6	'61 Imperial	\$2.50
LG4	'62 Plymouth	\$2.50
LG7	'64 Plymouth	\$2.50

BULK GENERAL PURPOSE GASKET MATERIAL

1/16" neoprene impregnated, sq/in	\$0.06
3/16" gray sponge neoprene, sq/in	\$0.05
3/16" black sponge neoprene, sq/in	\$0.05
1/2" black sponge neoprene, sq/in	\$0.07
1" black sponge neoprene, sq/in	\$0.10

Please specify the size you need. I've priced it per square inch so you only buy what you need.

BACKUP LIGHT LENS GASKET

BG6	'55 Imperial	\$2.50
6	'56 Crown Limo	\$2.50
TG29	'56 Desoto	\$2.50
BG5	'56 Imperial	\$2.50
BG13	'56 Plymouth	\$2.50
TG25	'57-'58 Desoto	\$1.75
BG14	'57-'59 Imperial	\$2.50
BG1	'59 Chrysler	\$2.50
TG38	'59 DeSoto	\$2.50
BG2	'60 Chrysler	\$2.25
BG16	'60-'62 Imperial	\$3.00
BG3	'61 Chrysler	\$2.25
BG9	'62 Chrysler	\$2.75
BG15	'62 Dodge	\$2.50
BG7	'63-'64 Dart	\$2.50
BG4	'64-'65 barracuda	\$2.50
BG17	'64 Plymouth	\$3.00
BG4	'65 Valiant	\$2.50
BG11	'66 Valiant	\$1.75
BG12	'66 Valiant hsg	\$3.50
BG10	'69 Charger	\$2.50

TAIL LIGHT HOUSING-TO-BODY GASKETS

HG1	'55 Chrysler	\$2.00
HG6	'56 Chrysler	\$2.50
HG22	'56 Desoto	\$1.25
HG2	'57-'58 Chrysler	\$1.25
HG23,	'57-'58 DeS. Needs 6 ea.	\$1.25
HG15	'58 Imperial	\$2.25
HG3	'59 Chrysler	\$1.50
HG25	'59 Desoto Needs 6 ea	\$1.50
HG4	'60 Chrysler	\$2.00
HG28	'60-'62 Imperial	\$4.00
	bu/hsg-body	
HG5	'61 Chrysler	\$3.50
HG9	'Chrys,lamp Fix.to hsg	\$2.00
HG2	'61 Chrysler. Fix to Bdy	\$2.00
HG7	'62 Chrysler	\$3.00
HG8	'62 Chrysler	\$2.00
	bu/hsg-body	
HG24A	'63 Dodge (large)	\$3.50
HG24B	'63 Dodge (small)	\$2.00
HG11	'63 Dart	\$2.50
HG27	'63-'64 Dart	\$2.25
	bu/hsg-body	
HG10	'64 Chrysler	\$1.50
HG26	'64 Dodge (moulded)	\$6.50
HG12	'64 Dart	\$2.50
HG13	'56 Dart	\$2.50
HG30	'66 Dart (moulded)	\$6.50
HG29	'65 Satellite	\$3.50
HG21	'65 Valiant	\$3.00
HG14	'66 Valiant	\$2.50
HG20	'68 Dart	\$3.50
HG18	'68 Satellite	\$3..50
HG18	'68 Roadrunner	\$3.50
HG19	'69 Roadrunner	\$3.50
HG17	'70 Challenger	\$5.50
HG16	Coronet	\$3.50

SUSPENSION

FRAME & BRAKE PARTS

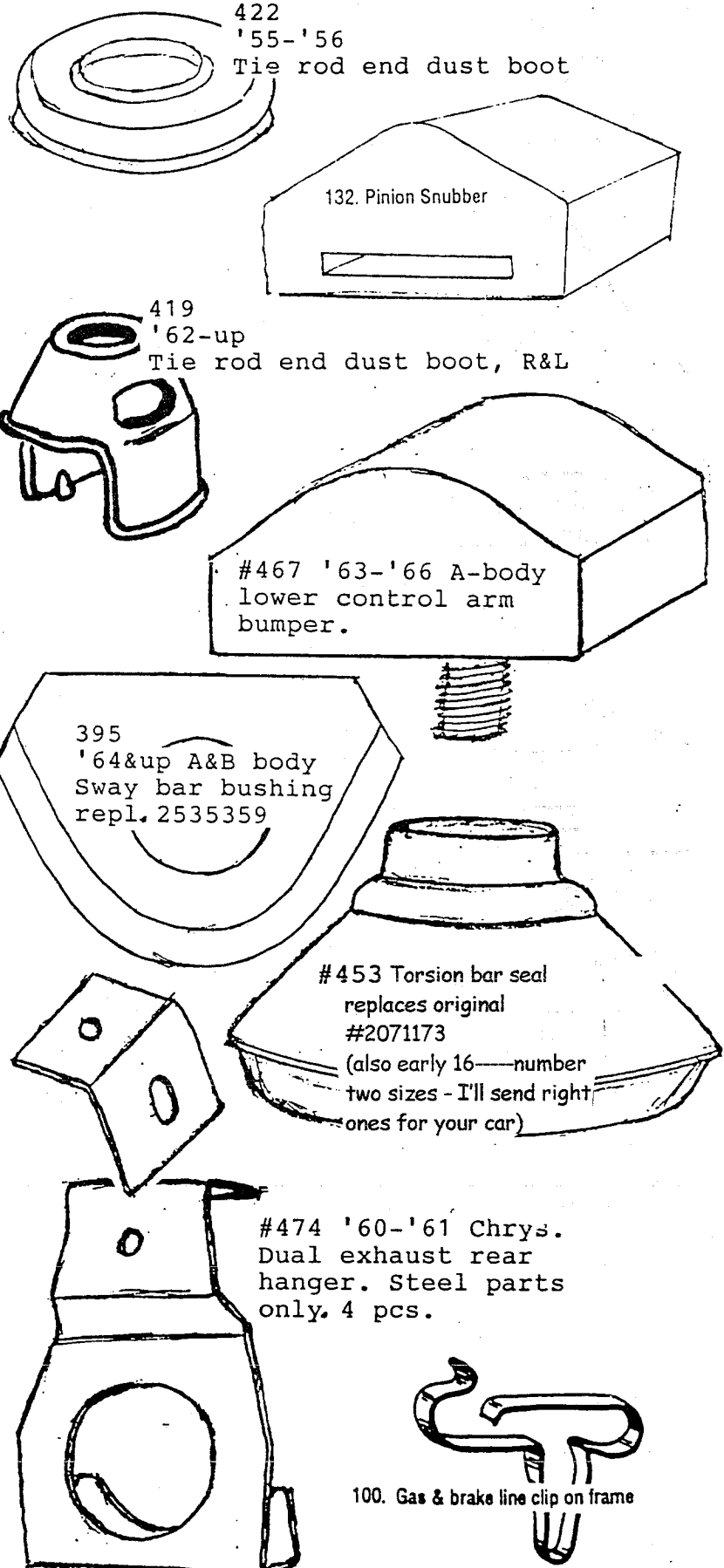

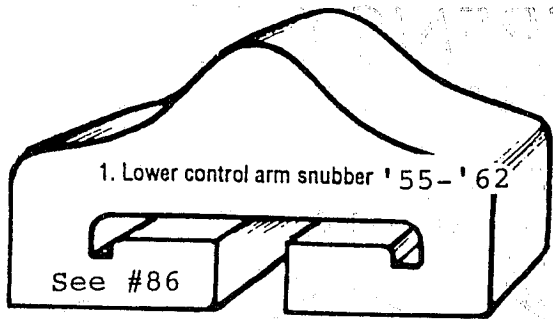

1. Lower control arm snubber '55-'62

See #86

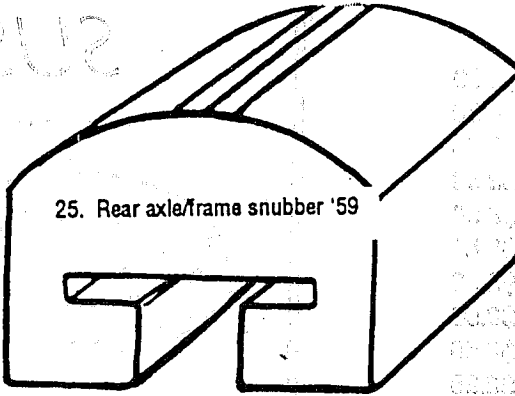

25. Rear axle/frame snubber '59

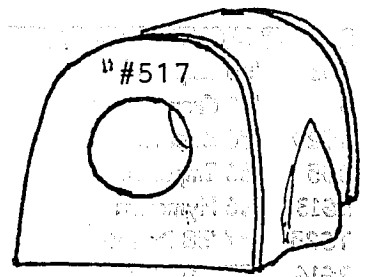

#517

#517 '55-'56 Sway bar bushing

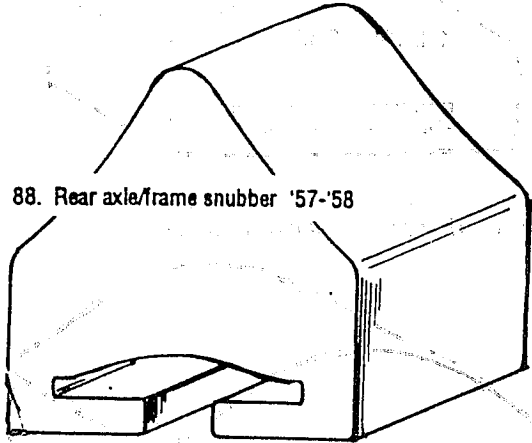

88. Rear axle/frame snubber '57-'58

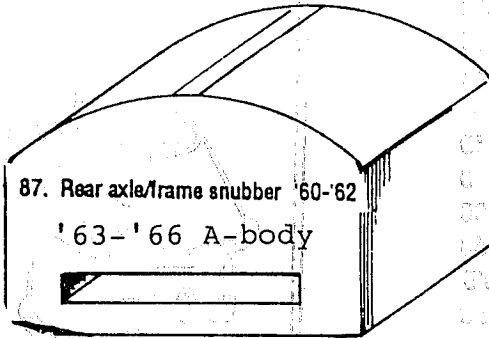

87. Rear axle/frame snubber '60-'62 '63-'66 A-body

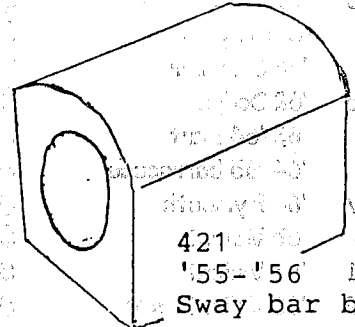

421 '55-'56 Sway bar bushing

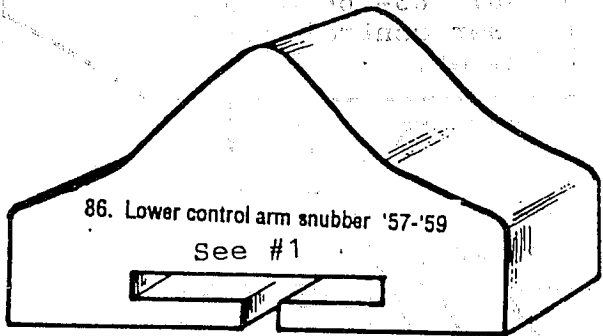

86. Lower control arm snubber '57-'59 See #1

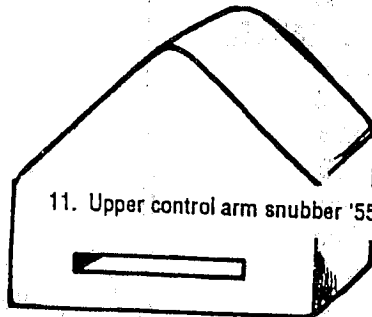

11. Upper control arm snubber '55, '56

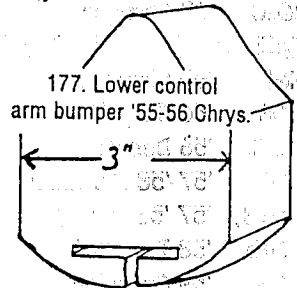

177. Lower control arm bumper '55-'56 Chrys.

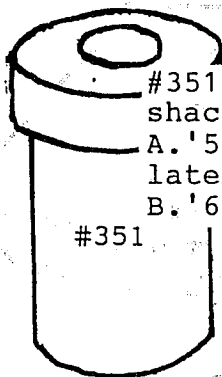

#351 Rear spring shackle bushing
A. '55-'64 maybe later C-body
B. '60-'74 A-body

#351

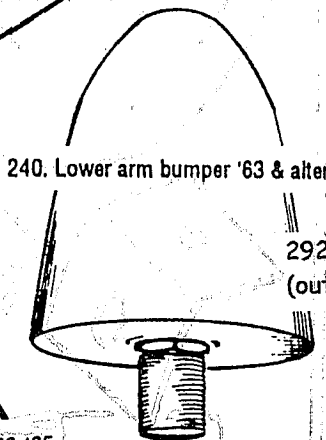

240. Lower arm bumper '63 & alter

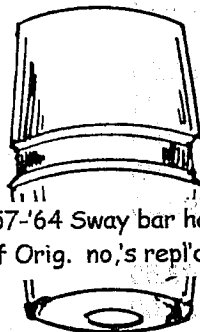

292. '57-'64 Sway bar hanger upper bushing (out of Orig. no.'s repl'd with good 2 pc units)

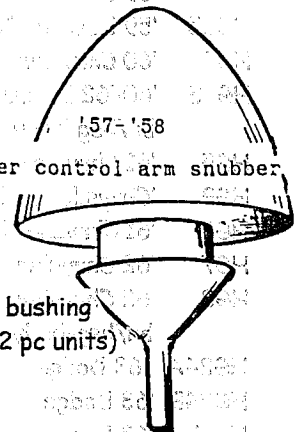

2. Upper control arm snubber '57-'58

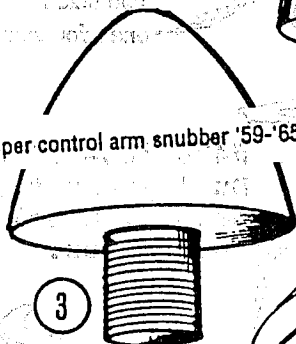

3. Upper control arm snubber '59-'65

3

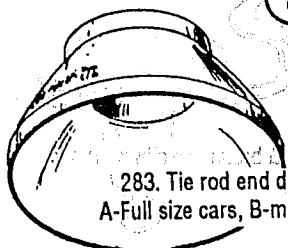

283. Tie rod end dust boot; A-Full size cars, B-medium size.

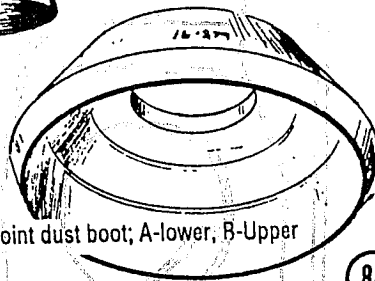

286. Ball joint dust boot; A-lower, B-Upper



#80 '57-'65 Sway bar bushing
A. 3/4" hole (most common)
B. 5/8" hole
C. 7/8" hole

80

80 - 81. Sway bar bushings '57-'65

Rubber only See also #292

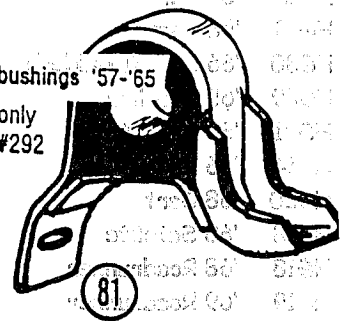

81

BRAKE PARTS

'57-'62 lockhead brakes
11"x2" brake shoes \$36.00 per
axle set. \$50.00 core charge

'57-'62 Brake hoses fr & rr
\$19.50 each
'55 Chrys. brake hoses fr & rr
\$19.50 each

WHEEL CYLINDERS

'55 Chrys. fr. wheel cyl. \$26.60ea
'55 Chrys. rear \$36.00ea

'56-'66 master cyl. \$74.50ea
for most cars w/o disc brakes

GREASE SEALS ALL \$4.50 each
Super bargain!

'56-'62 exc. Imp. front drum

'63-'70 all front (state make,
model, disc, and drum.)

UPPER & LOWER CONTROL ARM BUSHINGS

- #523 '58-'62 low priced C-body
- '63-'64 All G-body lower
- #524 '59-'64 All C-body upper
- #525 '62-'76 A-body, lower
- '62-'71 B-body, lower
- '70-'74 E-body, lower
- #526 '65-'73 C-body, upper

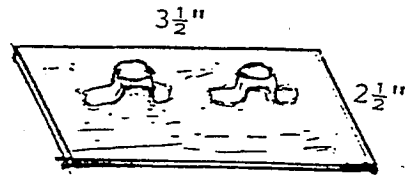

A. 2 button rear spring interliner reproduced in very hard urethane to simulate original canvas type with metal buttons. Used on early ('50s & early '60s) cars.

B. 2 button done in very hard black urethane to duplicate orig. on later cars.

C. Single oval button interliner used on early cars reproduced in very hard black urethane.

355. Heavy duty strut rod bushing kit (both sides included)

- A. '57-'64 Chrys., Desoto, Imp. All '57-'64 Ply., Dodge all exc. A-Body '65 B-Body, '60-'62 A-Body
- B. '66-'73 B-Body, '65-'73 Imp. '70-'73 E-Body
- C. '65-'73 Fury, '65-'73 Chrysler '65-'73 Monaco, Polara, Custom 880
- D. '63-'73 A-body

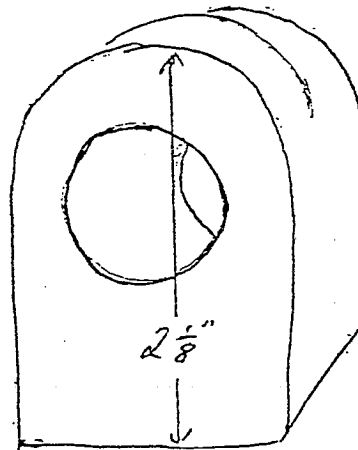

151,71-'72 B-body
sway bar bushing

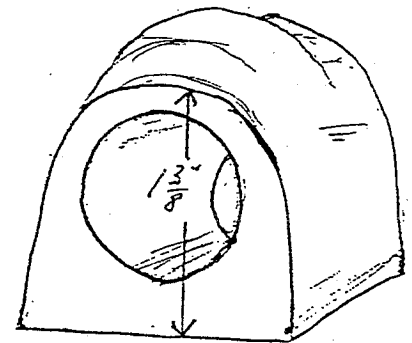

#325 '67-'68 Imp
Sway Bar bushing

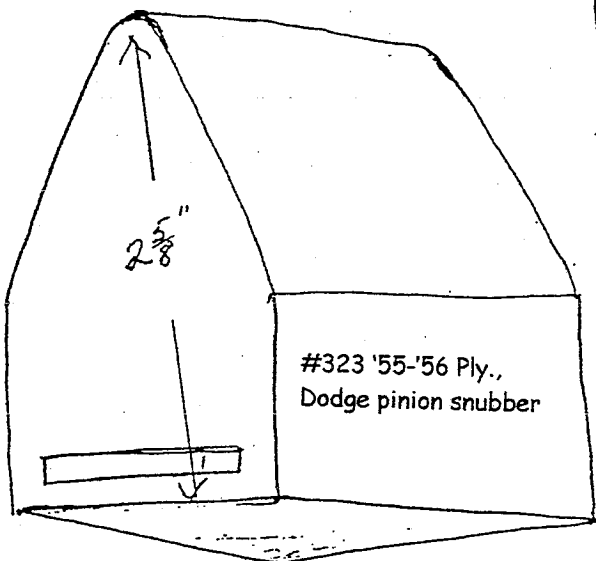

#323 '55-'56 Ply.,
Dodge pinion snubber

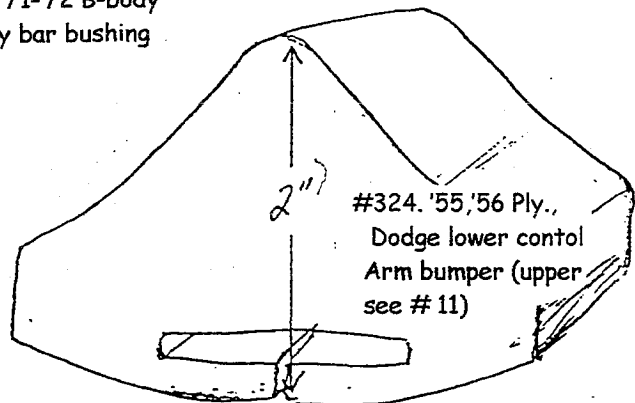

#324 '55-'56 Ply.,
Dodge lower control
Arm bumper (upper
see # 11)

'57-'59 CHRYSLER 392 HEMI RODS NOS \$250.00/set

MINIATURE LAMP

- | | |
|-------|-------|
| #63 | #1004 |
| #57 | #90 |
| #67 | #55 |
| #1093 | #87 |
| #1157 | #1157 |
- All \$.50 Cents each.

- | | |
|---------------------|---------|
| '57 Dodge | \$25.00 |
| '58 Dodge | \$25.00 |
| '59 Dodge | \$25.00 |
| '57 Plymouth | \$20.00 |
| '58 Plymouth | \$25.00 |
| '59 Plymouth | \$15.00 |
| '60 Plymouth | \$25.00 |
| '61 Plymouth | \$20.00 |
| '62 Valiant | \$20.00 |
| '54-'56 Dodge Truck | \$15.00 |

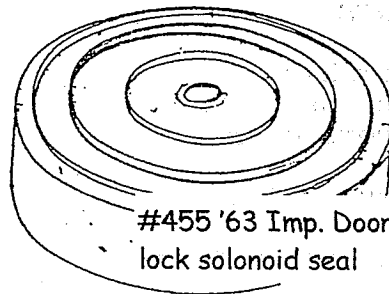

#455 '63 Imp. Door lock solenoid seal

NORS BACK UP LITE LENSES

- | | |
|--------------|---------|
| '57 Plymouth | \$25.00 |
| '62 Plymouth | \$20.00 |

PARKING LIGHT LENSES

- | | |
|-------------------|---------|
| '60 DeSoto (left) | \$30.00 |
|-------------------|---------|

USED TAIL LIGHT LENSES

- (not cracked or craze)
- | | |
|--------------|---------|
| '57 chrysler | \$25.00 |
|--------------|---------|



#541

'57-'58 Jiffy-Jet washer bags. Unbelievably accurate reproductions.

#542 '57-'61 300 reproduction side medallions. Beautiful accurate duplicates of originals from a steel injection mold. All holes are drilled for letters and numbers (new ones can be found on the repro. chrome page.).

#140D 1/2"-13 X 1 3/8"
bumper bolt--pan head
Not as rounded as 140A



#536 '64-'66 Conv.
Rear armrest pads. Molded in Dense self-skinning urethane foam. Black or Neutral color which you can paint to match interior Color. I must have your clean metal inserts from your old armrests to make these. R & L

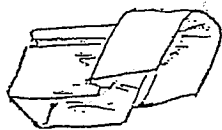
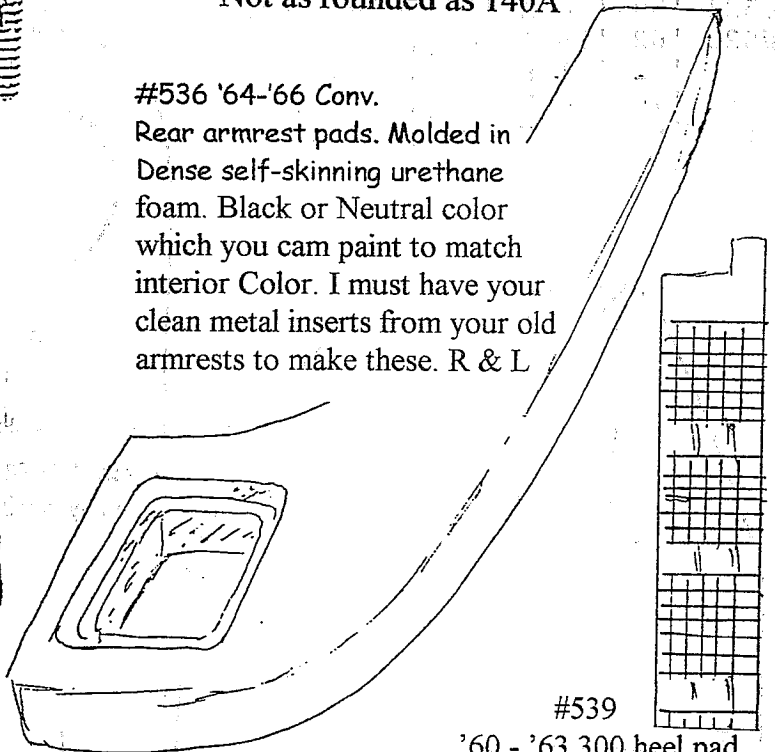

#256 '63 Imp. Division bar upper cushion

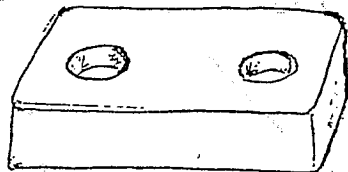

#538 '57 Dodge Pick-up hood Bumper

#539
'60 - '63 300 heel pad rubber inserts. Strip of 4 \$8.00

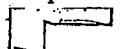

MORE NEW PARTS

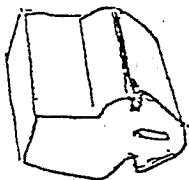

#545 Front side hood/
fender bumpers '66
Ply. C-body. (See
#239 Pg 23) for rear
side bumpers.

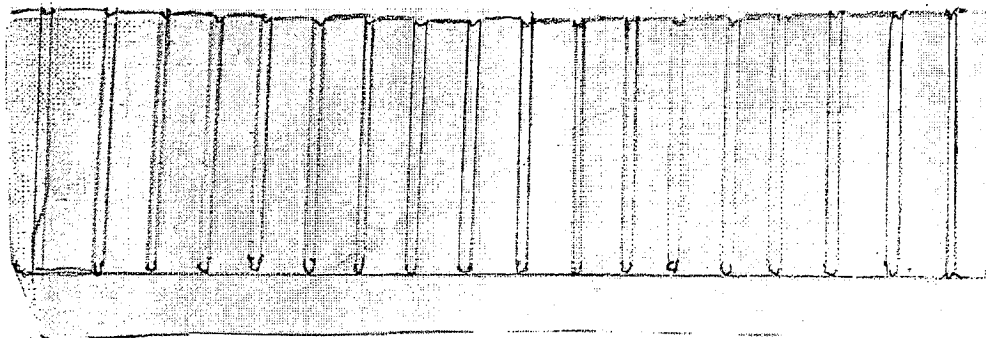
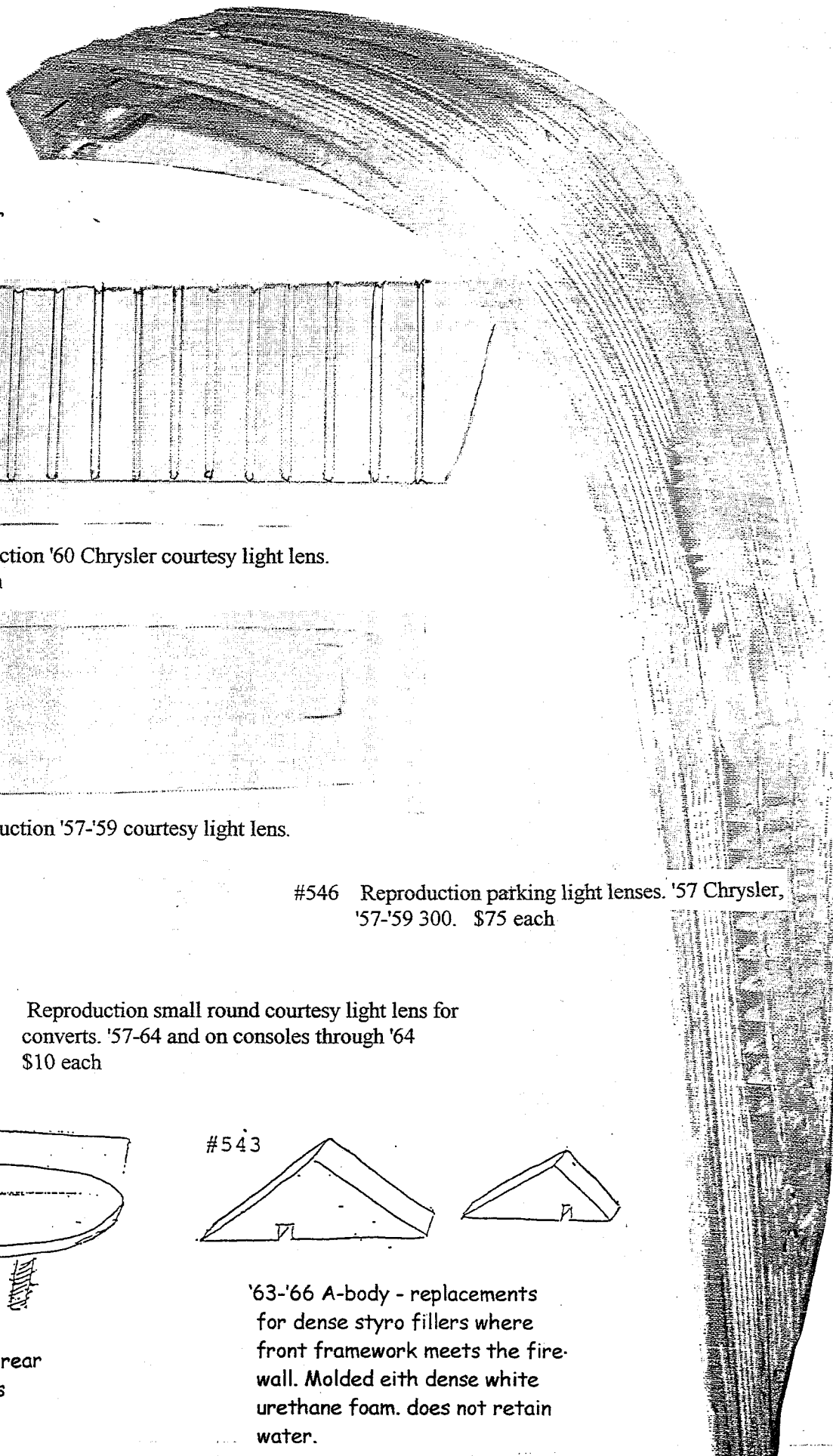

#547 Reproduction '60 Chrysler courtesy light lens.
\$30 each

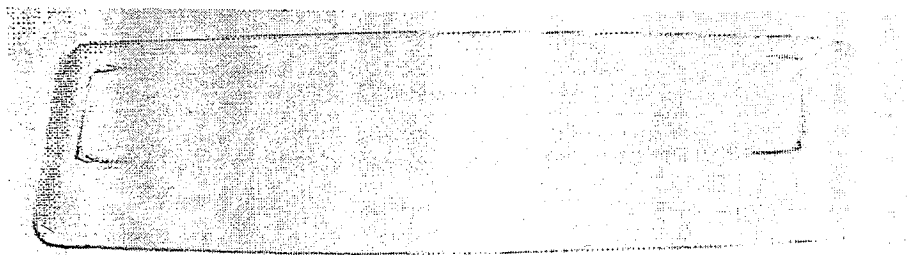

#330 Reproduction '57-'59 courtesy light lens.

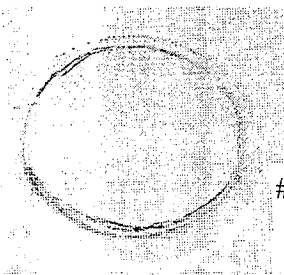

#548 Reproduction small round courtesy light lens for
converts. '57-'64 and on consoles through '64
\$10 each

#546 Reproduction parking light lenses. '57 Chrysler,
'57-'59 300. \$75 each

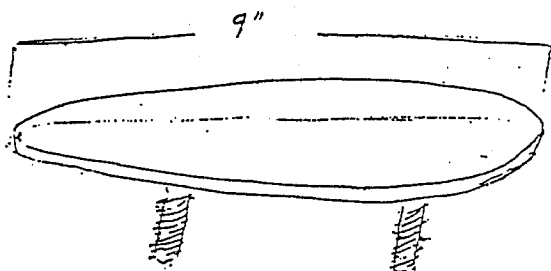

#544 '62 Dodge fr & rear
bumper guard pads
exchange

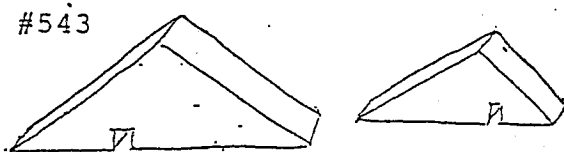

#543
'63-'66 A-body - replacements
for dense styro fillers where
front framework meets the fire-
wall. Molded with dense white
urethane foam. does not retain
water.

NEW REPRODUCTION CHROME PARTS

Replace your old pitted chrome with new parts for about the same price as rechroming. The difference is these are high quality special alloy reproductions that won't pit!

Here's the complete list of parts being reproduced now. No, they are not all done yet; I expect completion soon. Those marked with an * are done and they are beautiful. Keep in mind that these are not crude sand cast brass; they are high quality molded alloy parts which are chrome or 24k gold plated and are ready to install. You'll love them or your money back.

(listed according to year)

CHR17*	'55-'56 "CHRYSLER" 300 nose letters, set	\$105.
CHR18*	'55 300 front emblem	100.
CHR19*	'55 300 rear emblem	110.
CHR71*	'55 C69, C70 "IMPERIAL" deck lid script	80.
CHR68*	'55-'56 "CHRYSLER" dash panel script	28.
CHR66*	'55 "DODGE" hood and trunk script	105.
CHR57*	'55-'56 "DE SOTO" hood and trunk letters, set	43.
CHR58*	'55-'56 DeSoto roof or quarter medallion base	140.
CHR83*	'55 "CHRYSLER 300" quarter panel trim, set	28.
CHR72*	'55-'56 "IMPERIAL" dash panel script	32.
CHR94*	'55 "DELUXE" script [use with CHR73]	57.
CHR73*	'56 "NEW YORKER" fender script	147.
CHR74	'56 "IMPERIAL" rear door or quarter letters, set	38.
CHR84*	'56 "CHRYSLER 300B" quarter panel trim, set	42.
CHR104*	DeSoto "SPORTSMAN", 6.25in long, gold	43.
CHR69*	'56 Chrysler interior and front fender ornament [shield], gold/paint detail	60.
CHR69*	'57-'58 Chrysler, non-300, dash ornament [shield], gold/paint detail	
CHR64*	'56 Plymouth Forward Look quarter panel ornament, two-tone chrome May be used on other lines	
CHR63	'56 "DODGE" hood script	110.
CHR20*	'56 300 front emblem	125.
CHR21*	'56 300 rear emblem	72.
CHR27*	'57-'59 300 side medallion bezel	132.
CHR29*	'57-'58 300 trunk medallion bezel, 2pcs.	80.
CHR30	'57-'59 300 brake air scoop bezel, L or R	150.
CHR31*	'57-'59 300 brake air scoop bezel extension, L or R	24.
CHR32*	'59 300 trunk medallion bezel, 2pcs.	28.
CHR33*	'57-'59 all makes Sta/Wgn rear seat lift handle	28.
CHR34*	'57-'59 interior small "FIREFLITE" script, gold	110.
CHR35*	'57-'59 interior small "ADVENTURER" script	51.
CHR1*	'57-'59 300 "CHRYSLER" hood letters, set	17.
CHR2*	'57-'61 300 "300" side medallion numbers, each side	17.
CHR3*	'57 300 letter "C" for side medallion	17.
CHR4*	'58 300 letter "D" for side medallion	17.
CHR5*	'59 300 letter "E" for side medallion	17.
CHR6*	'60 300 letter "F" for side medallion	17.
CHR7*	'61 300 letter "G" for side medallion	28.
CHR8*	'57-'58 glovebox door medallion base	39.
CHR9*	'57-'59 Chrysler, DeSoto inside door handle, L or R	90.
CHR10A*	'56-'60 "ADVENTURER" quarter panel script, gold	80.
CHR10B*	'56-'60 "ADVENTURER" quarter panel script, chrome	85.
CHR11*	'56-'60 "FIREFLITE" fender script	30.
SUNVISOR MOUNTING PLATES [CHR12-CHR16]		
CHR12*	'57 all makes, exc. cvt., L or R	30.
CHR13*	'58-'59 all makes cvt., L or R	30.
CHR14*	'58-'59 all makes, exc. cvt., L or R	30.
CHR15*	'60-'64 all makes, exc. cvt., L or R	30.
CHR15*	'65-'66 A-body, exc. cvt., L or R	36.
CHR16*	'60-'64 all makes C-body cvt., L or R	95.
CHR22*	'57-'58 "DESOTO" hood letters, gold, set	92.
CHR23*	'57-'58 "DESOTO" trunk letters, gold, set	80.
CHR65*	'56-'57 DeSoto Adventurer quarter panel Forward Look, chrome/gold	85.
CHR107*	'57 DeSoto lower rear quarter pinchweld trim—cars w/o bumper ext. us	

CHR24*	'57 DeSoto front fender side ornament	65.
CHR70*	'57 "CHRYSLER" decklid name plate	72.
CHR96*	'57-'58 "CHRYSLER" dash script	32.
CHR69*	'56 Chrysler interior and front fender ornament [shield]	42.
CHR69*	'57-'59 Chrysler non-300 dash ornament [shield]	42.
CHR75*	'57-'59 "IMPERIAL" fender and trunk script	80.
CHR76	'57-'59 Imperial trunk lid handle and decal	70.
CHR79*	'57 "DODGE" hood letters, gold	85.
CHR80*	'57 "DODGE" trunk letters, chrome	75.
CHR99*	'57 Dodge "D500" ornament	125.
CHR81*	'57-'59 Imperial crown over headlights, gold	32.
CHR88	'57-'59 all makes fender mount antenna base	
CHR89*	'57-'59 nut used with CHR88 for power antenna	18.
CHR90	'57-'58 Chrysler, DeSoto rear antenna base	
CHR91*	'57 "NEW YORKER" fender script	85.
CHR86	'57-'59 all makes cvt. top latch	
CHR109*	'58 Dodge D500 emblem	130.
CHR93	'58 "NEW YORKER" fender script	
CHR87*	'58-'64 "300" interior numbers, set	48.
CHR36	'58, '61-'63 300 wheel cover center dome	
CHR100*	'59 300E "300" hood numbers	65.
CHR101*	'59 300E "300" trunk numbers	70.
CHR25*	'59 "DESOTO" hood and trunk letters	95.
CHR26	'59 DeSoto Fireflite quarter panel emblem bezel	
CHR106*	'59 DeSoto Sta/Wgn tailgate "EXPLORER" script	70.
CHR60*	'59 Plymouth "V" on trunk lid	24.
CHR61	'59 Dodge trunk and fender ornament	
CHR62*	'59 Dodge trunk letters, set	82.
CHR85	'59 DeSoto fender top ornament	
CHR77*	'59 swivel seat release handle	32.
CHR105*	'60 DeSoto interior "ADVENTURER" script	28.
CHR37*	'60 "CHRYSLER" hood script, gold	45.
CHR38*	'60 Chrysler trunk lid handle	30.
CHR78*	'60-'61 swivel seat release handle	32.
CHR59*	'60 "CHRYSLER" script and shield under trunk	95.
CHR97*	'60 Plymouth "SONORAMIC COMMAND POWER" emblem	95.
CHR67*	'60-'62 "NEW YORKER" glovebox script, gold	35.
CHR103*	'60-'61 "CHRYSLER" glovebox script, gold	35.
CHR82*	'61 "CHRYSLER" nameplate under trunk	80.
CHR92*	'62-'63 Imperial nose ornament, 3pcs	180.
CHR86	'63-'66 A-body cvt. top latch	
CHR56*	'63-'72 Pentastar ornament, right lower fender	15.
CHR39*	'63 Dart "DODGE" hood letters	62.
CHR40*	'63 Dart hood emblem bezel	34.
CHR41*	'63 Dart "GT" fender ornament	53.
CHR41*	'64 Dart "GT" roof panel ornament	53.
CHR43*	'63-'64 Dart, Valiant park light bezel	72.
CHR44*	'63 "DART" quarter panel script	42.
CHR45*	'65-'66 Dart fancy "GT" roof panel ornament	65.
CHR46*	'65 Dart "DODGE" hood script	42.
CHR47*	'65-'66 "DART" quarter panel letters	50.
CHR49*	'65 Dart GT "DODGE" trunk letters	57.
CHR48*	'65 Dart GT lower fender and door ornament, L or R	42.
CHR47*	'66 "DART" fender letters	50.
CHR49*	'66 Dart "DODGE" hood letters	57.
CHR50*	'66 Dart exc. GT "DODGE" script on trunk lid	54.
CHR51*	'66 Dart 270 fender side [louvers] ornament	38.
CHR108*	'66 Dart convert end pieces for top boot snap stud trim strip Pair	46.
CHR52*	'68 Dodge Coronet "DODGE" letters below trunk lid	75.
CHR53*	'68 Dodge "CORONET 440" or "CORONET 500" on quarter panel	150.
CHR54*	'68 Dodge Coronet "500" grille ornament	65.
CHR55*	'68 Round side marker light bezels, flat or beveled	25.
CHR95*	'68-'70 B-body manual antenna base	18.

REPRODUCTION SEAT FRAME & FLOOR PLASTIC

Accurate vacuum formed black plastic. Beautiful duplicates of original hard to find parts.

RP1 '57 Electric seat side covers. 2 door. except Imp. & Ply.
(black Only) \$200.00/ set.

RP2 '57-'58 Cover between electric-seat track and floor.
27" long. All except Imp. & Ply. \$90/set.

RP3 '59 cover between electric-seat Track and floor. All
except Imp. & Ply. \$90.00/set.

RP4 '57-'58 Imperial cover between electric-seat track and
floor \$110.00/set.

RP5 '59-'61 Imperial cover between electric-seat track and
floor \$100.00/set.

RP6 '58, '59-'61 without swivel. Electric seat adjuster cover.
\$110.00/set.

RP7 '59 swivel seat adjuster cover, with power seat.
\$90.00/set.

RP8 '60-'61 swivel seat adjuster cover, with power seat.
\$90.00/set.

RP9 '59-'61 swivel seat adjuster cover, with Manual seat.
\$90.00/set.

RP10 '60-'61 300 swivel seat pivot bracket covers \$90.00/set.

RP11 '60-'61 All Except 300 swivel seat pivot bracket covers.
\$90.00/set.

RP12 '60-'61 '60-'61 All swivel seat, with wire, except 300 wire
bracket covers on seat frame. \$58.00/set.

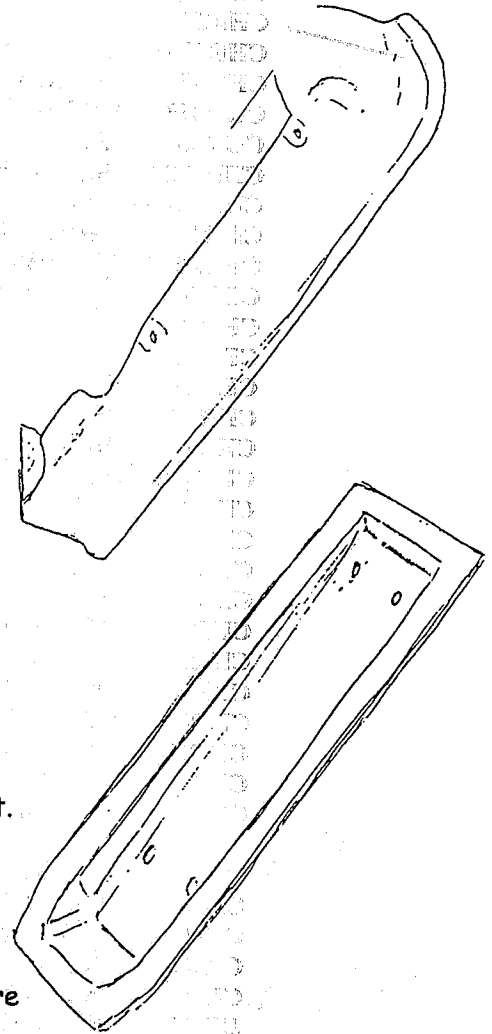

REPRODUCTION ALUMINUM PARTS

Stunning copies to enhance your restoration. die stamped—simply gorgeous.

(all sill plates are for 2 door HT & converts.) All \$400.00/set/

DOOR SILL PLATES

RA-1 '57-'58 Chrys

RA-4 '59 Des.

RA-7 '57-'58 Dodge

RA-2 '59 Chrys.

RA-5 '57-'58 500

RA-8 '59 Dodge

RA-3 '57-'58 Des.

RA-6 '59 300

ALL PRICES PLUS SHIPPING AND HANDLING

PRICE LIST CATALOG #9 1/04

1.	9.30	56.	1.25	102D.	4.85	117.	10.35	158.	pr9.25	195.	3.15
2.	6.85	57.	1.25	102E.	3.20	118.	4.60	159A.	1.00	196.	3.15
3.	8.10	58.	1.25	102F.	8.55	119.	11.80	159B.	1.00	197.	6.65
4.	.95	59.	2.35	102G.	5.10	120.	6.25	160.	4.35	198.	3.45
5.	.95	60.	26.50	102H.	5.10	121.	3.45	161.	4.35	199.	2.10
6.	.85	61.	2.10	102I.	2.65	122.	3.45	162A.	4.25	200.	2.05
7.	1.90	62.	5.65	102J.	6.20	123.	---	162B.	4.15	201.	2.25
8.	1.90	63.	8.25	102K.	5.45	124.	10.65	163.	6.95	202.	2.25
9.	1.35	64.	2.10	102L.	3.85	125.	2.65	164.	1.15	203.	2.20
10.	1.35	65.	32.20	102M.	5.15	126.	pr10.45	165.	2.00	204.	2.25
11.	7.05	66.	pr6.65	102N.	11.90	127.	pr29.60	166.	7.80	205.	2.00
12.	1.05	67.	pr6.65	102O.	7.20	128.	pr29.60	167A.	.85	206A.	pr5.25
13.	1.30	68.	pr6.65	102P.	16.40	129.	2.10	167B.	1.00	206B.	pr6.40
14.	1.85	69.	pr10.20	102Q.	7.85	130.	1.65	168.	6.60	207.	2.10
15.	1.85	70.	8.90	102R.	7.85	131.	1.65	169.	.85	208.	3.45
16.	1.90	71.	7.20	102S.	4.50	132.	8.10	170.	.85	209.	3.45
17A.	pr5.85	72.	pr15.20	102T.	7.55	133.	1.55	171A.	.75	210.	5.95
17B.	pr5.85	73.	18.40	102U.	8.85	134.	1.45	171B.	.75	211.	1.40
18.	2.05	74.	18.40	102V.	8.85	135A.	.35	172.	1.20	212.	2.15
19.	2.05	75.	7.25	102W.	7.50	135B.	.35	173.	1.15	213.	3.00
20.	1.75	76.	19.40	102X.	6.95	135C.	.35	174A.	.95	214.	52.00
21.	2.05	77.	32.40	102Y.	5.30	135D.	.35	174B.	.95	215.	10.00
22.	1.45	78.	1.55	102Z.	15.10	135E.	.35	175.	.70	216.	3.00
23.	2.20	79.	6.30	102AA.	5.25	135F.	.35	176.	.80	217.	3.50
24A.	6.55	80A.	5.30	102BB.	8.60	135G.	.35	177.	13.00	218.	3.60
24B.	6.55	80B.	5.30	102CC.	8.85	135H.	.30	178A.	.45	219.	3.00
25.	8.00	80C.	5.30	102DD.	5.30	135I.	.30	178B.	.45	220.	2.50
26.	1.85	81.	5.30	102EE.	8.30	135J.	.35	178C.	.40	221.	3.00
27.	3.60	82.	21.70	102FF.	4.90	135K.	.35	178D.	.50	222.	1.95
28.	3.60	83.	20.85	102GG.	8.50	135L.	.35	179.	.85	223.	1.95
29.	3.60	84.	21.70	102HH.	6.10	135M.	.35	180A.	.45	224.	1.95
30.	7.65	85.	19.70	102II.	8.90	135N.	.35	180B.	.40	225.	1.80
31A.	1.20	86.	9.30	102JJ.	8.90	136A.	.30	181.	6.45	226.	19.25
31B.	1.20	87.	9.10	102KK.	10.00	136B.	.30	182.	7.55	227.	6.65
32.	1.00	88.	10.40	102LL.	4.25	136C.	.35	183.	1.95	228.	3/5.65
33.	1.30	89.	3.70	102MM.	7.25	136D.	.35	184.	6.75	229.	1.00
34A.	32.00	90.	11.45	102NN.	2.45	137.	1.10	185A.	.45	230.	1.00
34B.	32.00	91.	3.85	102OO.	2.45	138.	.85	185B.	.35	231.	1.00
35.	5.60	92.	2.30	102PP.	8.85	139.	.95	185C.	.45	232.	1.60
36.	3.05	93.	13.00	102QQ.	3.75	140.	2.10	185D.	.45	233.	7.90
37.	1.05	94A.	2.65	102TT.	3.85	141.	1.20	186.	.65	234.	3.00
38.	pr13.25	94B.	13.65	102UU.	35.00	142A.	.80	187.	5.45	235.	3.30
39.	Pr19.95	95.	2.50	102VV.	35.00	142B.	.80	188.	.85	236.	2.30
40.	2.45	96.	2.50	102WW.	9.30	143.	1.20	189A.	3.05	237.	2.00
41.	3.50	97.	2.50	102XX.	5.35	144.	.80	189B.	2.95	238.	2.40
42.	2.00	98.	5.05	102YY.	3.10	145.	.45	190A.	.70	239.	2.20
43.	2.00	99.	1.65	102ZZ.	7.50	146A.	.65	190B.	.70	240.	12.60
44A.	2.00	100.	1.15	103.	4.55	146B.	.70	190C.	.75	241.	5.80
44B.	2.15	101A.	1.20	104.	2.40	147A.	.55	190D.	.75	242.	1.35
45.	1.85	101B.	.75	105.	13.00	147B.	.80	190E.	.80	243.	.85
46.	1.75	101C.	.75	106.	13.00	148.	.80	190F.	.90	244.	3.30
47.	1.75	101D.	.95	107.	12.80	149.	17.00	190G.	.95	245.	1.05
48.	2.05	101E.	1.10	108.	13.00	150.	1.75	190H.	1.00	246.	1.05
49A.	3.10	101F.	1.30	109.	5.85	151.	5.75	190I.	1.05	247.	1.35
49B.	3.55	101G.	1.45	110.	1.85	152.	.85	190J.	1.10	248.	1.00
50.	1.70	101H.	1.55	111.	3.65	153.	1.75	191.	1.95	249.	62.00
51.	2.50	101I.	1.05	112.	pr9.10	154.	.85	192A.	3.95	250.	---
52.	2.55	101J.	1.20	113.	5.85	155.	.85	192B.	3.95	251.	3.25
53.	2.05	102A.	3.95	114.	2.20	156A.	3.40	193.	1.30	252.	19.70
54.	1.50	102B.	5.40	115.	1.35	156B.	3.10	194A.	4.20	253.	19.25
55.	1.95	102C.	2.65	116.	10.35	157.	pr11.40	194B.	3.30	254.	10.75

255.	3.10	313.	1.85	361B.	3.25	417.	pr18.50	476.	15.25	529.	2.45
256.	pr8.35	314.	2.95	362.	3.70	418A.	38.00	477.	pr18.20	530A.	16.80
257.	21.25	315.	1.40	363.	4.00	418B.	38.00	478.	3.75	530B.	14.90
258.	pr20.50	316A.	14.25	364.	13.25	419.	6.35	479.	45.00	531st	100.00
259.	39.00	316B.	14.25	365.	4.00	420.	2.65	480.	19.75	532.	---
260.	4.40	317A.	11.00	366.	1.60	421.	5.00	481.	1.65	533.	st17.00
261.	3.00	317B.	11.00	367.	2.20	422.	2.00	482.	1.00	534.	1.70
262.	1.90	318A.	10.75	368.	2.50	423.	1.50	483.	14.75	535.	2.50
263.	6.75	318B.	10.75	369.	pr23.00	424.	18.25	484.	st11.75	536.	45.00
264.	1.35	319.	5.50	370.	pr20.50	425.	yd1.85	485.	9.30	537.	---
265.	2.10	320A.	2.40	371.	2.00	426.	9.90	486.	16.30	538.	2.50
266.	3.50	320B.	7.60	372.	2.30	427.	28.50	487.	pr18.80	539.	---
267.	5.40	320C.	5.50	373.	2.30	428.	6.65	488.	1.95	540.	N/A
268.	3.55	320D.	4.25	374.	2.30	429.	---	489.	pr24.50	541.	70.00
269.	5.40	321.	4.65	375.	ft4.50	430.	2.20	490A.	3.00	542.	60.00
270.	2.35	322.	5.55	376.	2.10	431.	2.20	490B.	3.00	543.	st12.75
271.	25.65	323.	10.65	377.	2.10	432.	2.30	490C.	3.00	544.	14.80
272A.	8.20	324.	10.65	378.	6.00	433.	3.80	491.	1.55	545.	2.10
272B.	7.90	325.	5.10	379.	4.90	434.	3.80	492.	pr22.50		
273.	54.00	326.	27.20	380.	3.35	435.	pr18.50	493.	1.55		
274.	1.60	327.	11.00	381.	st95.00	436.	pr15.75	494.	1.80		
275.	1.35	328.	35.80	382.	5.55	437.	pr15.75	495.	1.75		
276.	2.45	329.	1.60	383.	5.50	438.	r15.75	496.	1.10		
277.	2.00	330.	28.50	384.	1.10	439.	2.10	497.	2.85		
278.	5.85	331.	1.20	385.	1.00	440A.	8.80	498.	2.50		
279.	1.35	332.	2.10	386.	5.50	440B.	7.75	499.	2.70		
280.	1.35	333.	20.00	387.	6.60	441.	8.80	500.	2.05		
281.	2.50	334.	18.00	388.	4.45	442.	11.90	501.	4.20		
282.	1.65	335A.	20.25	389.	5.85	443.	1.65	502.	17.25		
283A.	1.65	335B.	20.25	390A.	16.50	444.	8.80	503.	1.15		
283B.	1.65	336.	2.75	390B.	12.50	445.	3.00	504A.	4.45		
284.	20.50	337.	2.00	390C.	19.75	446.	5.90	504B.	5.50		
285.	54.00	338.	2.95	391.	5.50	447.	5.90	504C.	5.55		
286A.	1.85	339A.	4.00	392.	11.75	448.	3.75	505.	1.15		
286B.	1.85	339B.	4.00	393.	3.75	449.	29.50	506.	1.95		
287.	5.90	339C.	4.00	394A.	st5.25	450A.	29.50	507.	1.90		
288.	1.35	340.	2.95	394B.	st5.25	450B.	29.50	508.	8.40		
289.	2.00	341.	pr24.00	395.	7.20	451.	1.40	509.	1.45		
290.	7.75	342.	2.10	396.	1.80	452.	6.20	510.	---		
291.	3.65	343.	pr7.50	397.	1.05	453.	8.80	511.	pr16.00		
292.	4.40	344.	2.45	398.	1.35	454.	12.80	512.	pr18.00		
293.	11.90	345.	3.10	399.	1.80	455.	4.85	513.	pr16.00		
294A.	2.00	346.	1.40	400.	1.10	456.	12.80	514.	pr21.00		
294B.	1.00	347.	1.45	401.	1.10	457.	2.10	515.	pr6.00		
295.	3.75	348.	5.10	402.	7.00	458.	6.50	516.	7.00		
296.	2.65	349.	5.50	403.	10.50	459.	3.65	517.	7.00		
297.	6.00	350.	18.00	404A.	7.50	460.	st3.85	518.	23.00		
298.	22.25	351A.	2.65	404B.	7.50	461.	pr9.50	519A.	5.50		
299.	7.25	351B.	2.75	405A.	3.70	462.	pr9.50	519B.	5.50		
300.	7.00	352A.	15.00	405B.	4.25	463.	pr4.25	520.	1.75		
301.	2.30	352B.	16.75	406.	1.85	464.	see/cat	521.	28.00		
302.	1.85	353.	3.00	407.	1.20	465.	4.85	522st	200.00		
303.	1.95	354.	8.45	408.	1.90	466.	10.20	523.	9.20		
304.	1.95	355A.	45.00	409.	8.65	467.	9.85	524.	8.20		
305.	22.75	355B.	45.00	410.	15.75	468.	7.40	525.	7.40		
306.	2.40	355C.	45.00	411.	14.00	469.	10.20	526.	10.60		
307.	ft1.30	355D.	45.00	412.	pr14.75	470.	1.80	527A.	3.45		
308.	5.50	356.	8.70	413.	2.30	471.	4.80	527B.	2.85		
309A.	pr21.20	357.	pr24.50	414.	3.20	472A.	29.50	527C.	2.75		
309B.	pr22.75	358.	pr19.80	415.	6.65	472B.	29.50	528.	pr9.00		
310.	2.40	359.	pr13.75	416A.	2.10	473.	1.55				
311.	1.75	360.	pr18.75	416B.	2.10	474.	15.25				
312.	6.50	361A.	3.25	416C.	2.10	475.	1.95				

MOLDING CLIPS

2332.	1.85
2356.	1.85
2789.	1.95
8386.	1.85
8398.	1.60
8399.	1.70
8400.	1.95
A12514.	1.75
A12618.	1.05
A12619.	1.20
A12620.	1.35
A12744.	1.85
A12752.	1.95
A12943.	1.00
A13164.	1.10
A19953.	1.00
A21977.	1.90
A22151.	1.10

UNDERHOOD INSPECTION STAMPS

These stamps complete the detail job on your restoration. Rent them for a month and stamp all the cars in your chapter. Price is \$10.00. I pay postage one way.

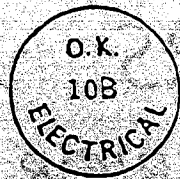

A NOTE ON RUBBER PARTS

Virtually all the small rubber parts are made with room-temperature curing urethane. This is the only economically feasible way to make so many different parts which are all very low demand, commercially speaking. They turn out very well and I'm always using the latest compounds available for the best quality. The weatherstrips are commercially made exclusively for me in the USA. They are made of the highest quality material available. Many have been in service for over 20 years and still good. PLEASE NOTE: I can't make parts with steel cores unless you send me your old ones to be able to reuse the metal. Please do not send cores that are broken or have studs broken or missing. In such cases, burn off the old rubber and repair the core before sending it. I have had the cores for #128's made since these are so often ruined with missing parts. Extra core cost on these is \$5.

PHONE AND PHONE ORDERS

Since most items are hand produced after I receive an order, you really won't save much, in any, time by calling in an order. The reality of the situation is that often I don't hear the phone and when I do, I might not be able to drop what I'm doing it to answer it. Also the fact that the computer and FAX are on the same line ties up the line most of the time. I'm basically a one man shop and simply can't take time to talk on the phone. So—please FAX or email any questions you may have. Early in the morning for those living east of the Mississippi and late at night for west coast is the best time to find the line clear. Email is a good way for questions, probably the best way. Keep in mind that I don't have a single part available any more that isn't listed in the catalog, so there is no need to ask. Also a note on emails—Often the computer crashes and they're lost or, my blearily late night eyes don't catch it while deleting the 150-200 daily junk emails, so if you don't hear back from me in a couple days, please send the email again. After all this fancy electronic stuff, good old US snail mail is by far the best way to go, especially when sending an order. It's what I'm set up to handle and it normally goes quite smoothly. If you are unsure of something you want to order, please feel free to just describe what you need on your order and I'll fill in the blanks. I'm very familiar with these cars and will know what you need 99% of the time. Just guess on the money and we'll sort it out when I ship. I never hold an order for any amount due and often ship before I even get to the bank to deposit checks. Money orders or cashier's checks are a waste of your time and money (with the exception of overseas orders). They have no bearing on how quickly I ship. Your personal check is always fine with me. I now take payment through PayPal online. My email address is my PayPal name.

RETURNS

Simply put: You don't like it, return it for a refund (naturally unused). However, unless I messed up, you pay all shipping.

PRICES

All items are priced as fairly as possible. Over the last few years, the prices of materials and manufacturing have gone up tremendously; many have almost doubled in less than 5 years! Catalog #8 was in print for approx. 5 years and the prices tended to stay the same. It was a shock for me on some of the cost when I double checked for pricing on catalog #9. Prices should remain stable for a year or two, but I must warn you that all prices are subject to change without notice.

TERMS

My normal business routine is you send in your order with a check for the full amount unless arrangements are made in advance.

DELIVERY TIME AND SHIPPING

I ship UPS whenever possible especially in light of the new high postal rates. Please note that UPS does not deliver to a PO box. A street address is required. The order form states 15% shipping and handling. This has worked out to be quite accurate on most orders. On especially large (or otherwise expensive) orders the 15% may be excessive. In such cases, I'll leave it to you to guess the cost and I'll rectify it after I've packed the order. You will then either get a refund or an amount due on your copy of the order. I always refund excess shipping. Please allow 6-8 weeks for delivery. Most orders go in less than 4 weeks, but it depends on how busy things are at the time. Especially large orders take longer, so if there is a group of parts you would like first to keep the project going, let me know and I will accommodate you as best as possible.

A PERSONAL NOTE

The last few years have been rough, both business-wise as I've lost several vendors and contending with the ongoing nightmare of trying to keep the parts coming, and on a personal level. I've been at this for better than 25 years and most of that has been 14 hour days—7 day a week. I'm not so young as I used to be (no kidding!) and the long hours without a break started taking a heavy toll. Fortunately, I got the right therapy (no, not mental :-)) and I'm doing much better. Not that I can put in the kind of hours that I used to, but at least things are getting better. More time off would be the final cure, so I'm humbly asking you to please order as far in advance as you can, so I don't end up holding up your project and also having that couple month window allows me to make items in batches which is much more efficient. Rush orders require stopping everything and setting up for just one item and then another and so on. I sure appreciate this and I want to thank all my loyal customers for their unending patience these last few years. Thanks!!!

New Stuff!

#600 '60-'62 firewall "keyhole" grommets.

(See #390 Page 20)

Large blocks are 3/4" thick;
Small blocks are 5/16" thick.

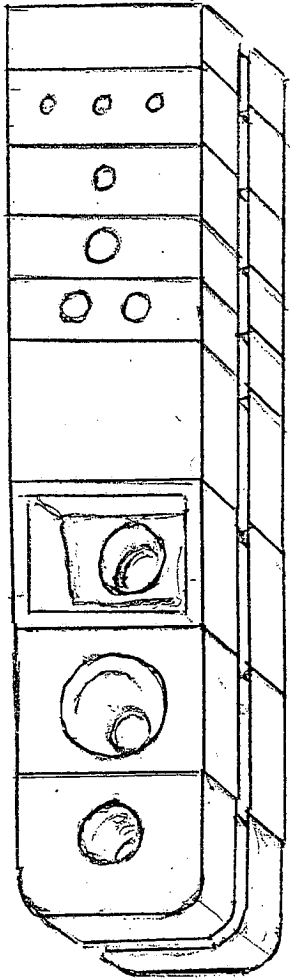

A. Small blank \$2.50

B. Remote mirror cables \$3.00

C. Hood release cable \$3.00

D. Vac. hose or speedo cable \$3.00

E. A/C vac. motor hoses \$3.00

F Large blank \$2.75

G. Push button cable \$3.50

H. Speedo cable \$3.50

I. Main wire loom (bottom rounded block) \$3.50

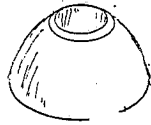

#54B '60-'64 convert. top pin seal. \$1.65

#552 '60-'62 center piece for visor pins \$8.00
A. non-convert.
B. convert

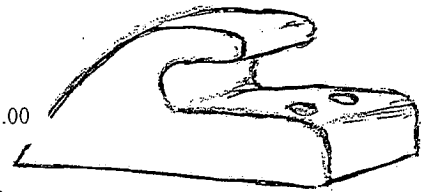

#550 '60-'62 300 insulator between the top end of front console and dash. \$5.00
Often missing piece prevents squeaks (well--this one anyway)

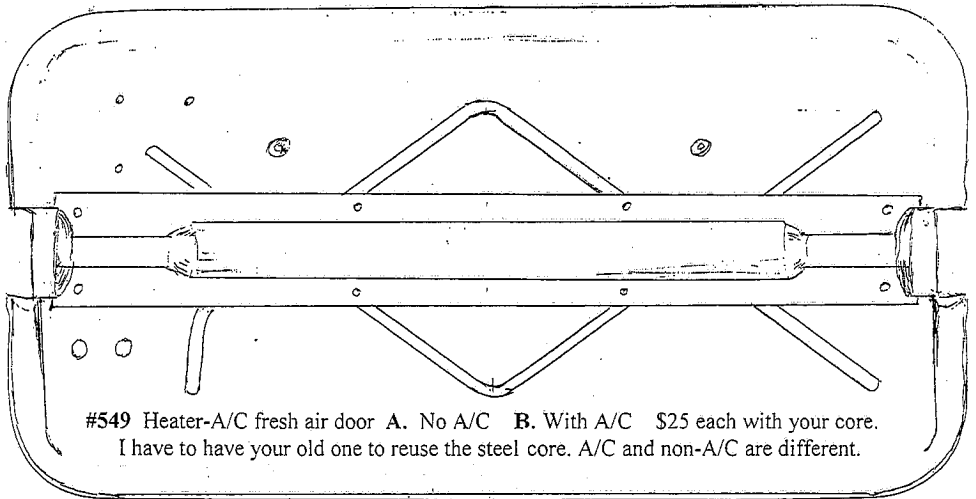
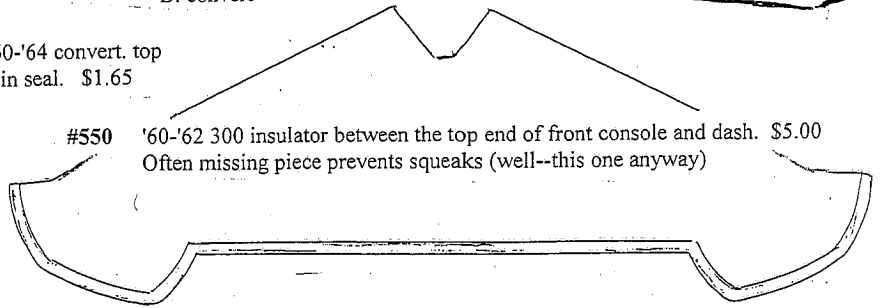

#549 Heater-A/C fresh air door A. No A/C B. With A/C \$25 each with your core.
I have to have your old one to reuse the steel core. A/C and non-A/C are different.

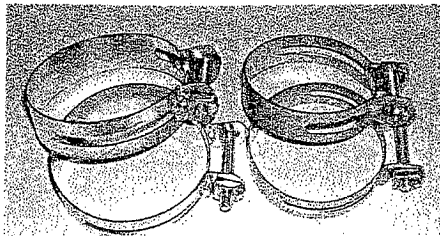

#558 '60-'64 ram intake equalizer tube hose clamps. Correct original style. Set of 4 (two sizes) \$10

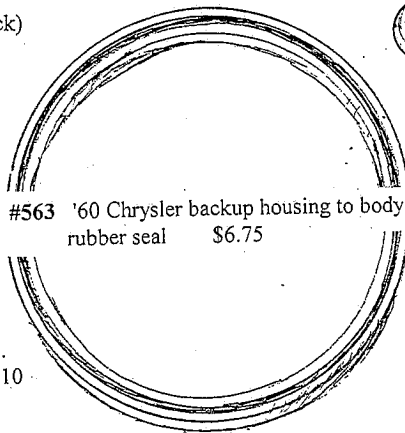

#563 '60 Chrysler backup housing to body rubber seal \$6.75



#555 '66 A-body lic. wire grommet \$3.50
Two small holes. Will need to be split to install wires and super glued back together.



#560 '60 imperial vent frame upper cushion \$7.20/pair

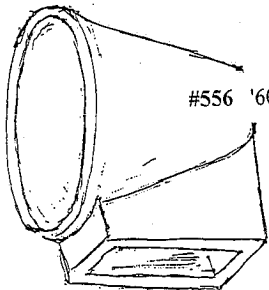

#556 '60-'61 starter solenoid boot \$6.00

#568 Oval air filters

A. '57-'58 single carb; '57 dual carb \$12.00 each
B. '58-'62 dual carb (except rams) \$22.00 each

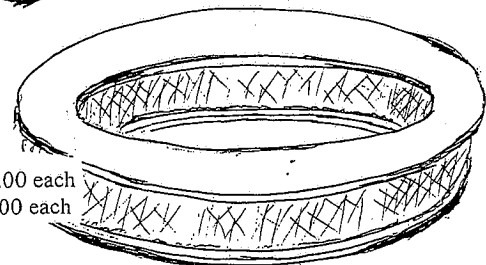

#557 '60-'61 starter hot lead insulator \$3.50

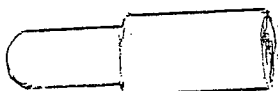

#561 '60-'62 visor tip \$4.00

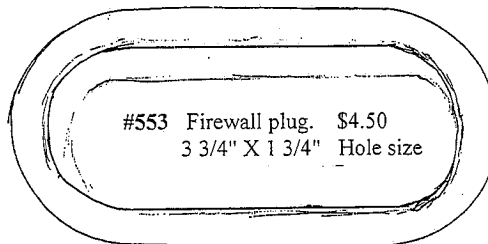

#553 Firewall plug. \$4.50
3 3/4" X 1 3/4" Hole size

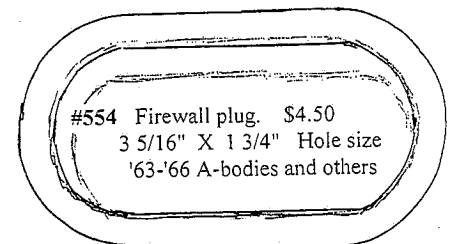

#554 Firewall plug. \$4.50
3 5/16" X 1 3/4" Hole size
'63-'66 A-bodies and others

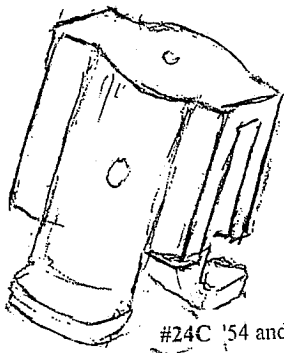

#24C '54 and earlier steering shaft insulator \$6.75

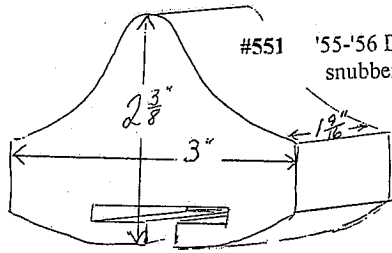

#551 '55-'56 Dodge lower control arm snubber \$9.50

#562 '57-'58 Dodge truck molded section of door weatherstrip \$14.00/set

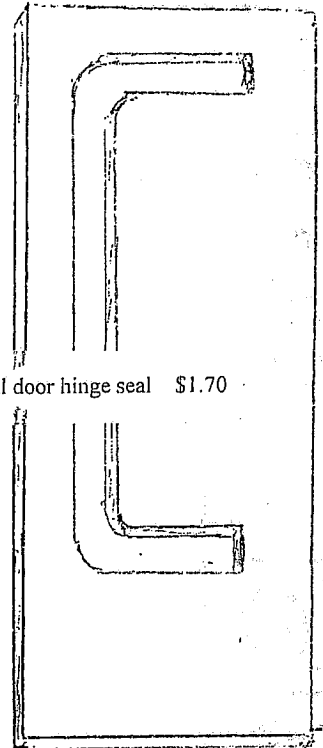

#559 '57 and up Imperial door hinge seal \$1.70

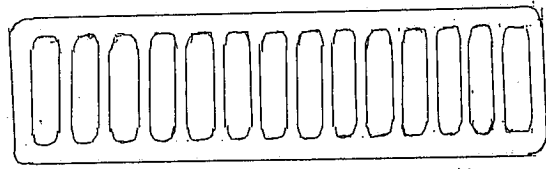

#567 '63 Chrysler brake pedal (stainless trim not included) Need your old one for the steel core. \$28

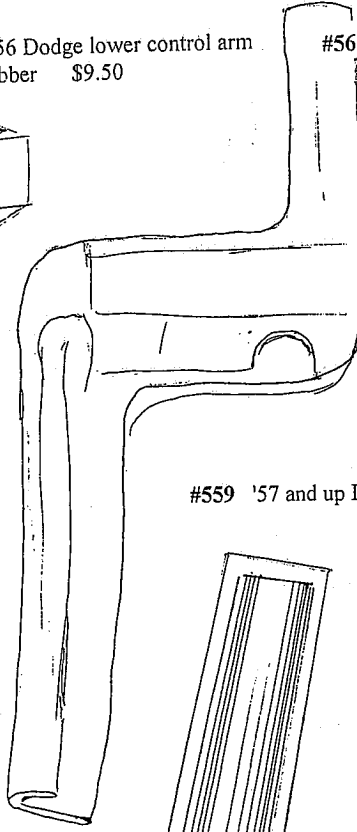

#566 '63 Chrysler gas pedal (stainless trim not included) Need your old one for the steel core. \$32

Decals and more new parts

- #537 - Oil lines are back! Better than ever.
 - A. '57-'59 oil pressure gauge line ... \$24.00
 - B. '57-'58 A/C set of 4 \$75.00 (some '57 cars may require adapting the return line to the engine)

#510 - See page 22. Starter, generator and distributor tags are back! Screen printed aluminum tags accurately duplicate the original look. These are blanks as far as part and serial numbers go. You'll have to have a local engraver do that part. \$10.00 ea.

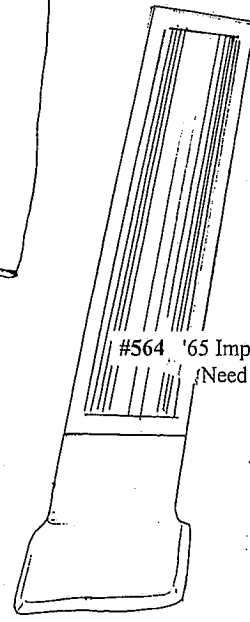

#564 '65 Imperial gas pedal (stainless trim not included) Need your old one for the steel core. \$35

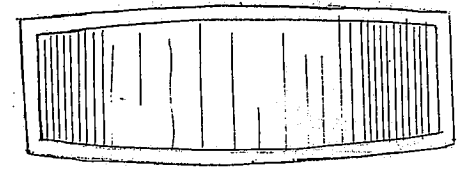

#565 '65 Imperial brake pedal (stainless trim not included) Need your old one for the steel core. \$30

New Speedometer & Tachometer Cables!

Original type flexible steel casing. LIMITED QUANTITY NOS ... '62 & up A-body...60" long casing.... \$35.00

Generic lengths

- '61 & earlier
- '56 & earlier Chrysler...79".... \$38.00ea.
- '57-'61 all...70".... \$35.00ea.
- '62 & up
- A-body...60".... \$40.00ea.
- '62 & up, B-body & some C-body...70".... \$42.00ea.
- '62 & up, some C-body...80".... \$45.00ea.

I'm very limited on samples for various years, so if you order with your original measurements of casing length, I'll make the cable to your specs. Price will be that of the nearest generic length.

Auto Pilot cables

- '58-'61 trans to unit...50".... \$38.00
- '62-'64 trans to unit...50".... \$42.00
- '58-'64 unit to speedometer...29".... \$25.00

Once again, can make to your specs.

All Trans to Auto Pilot housings & cables are heavy duty size as original.

Tachometer cables

- '60-'62 300 tachometer cables, original extra large casing size... \$40.00ea.

Late March update

'55,'56 decals coming real soon. Lots of them! The chrome project is once again back on line. The huge quagmire caused by the company owner's death has passed. The new owners have promised me that I will have everything back in stock in 90 days (about end of May). So far they're making good on their promise. Already I have C300 and 300 B front emblems back in stock. Gold Adventurer scripts just arrived and many more are nearing completion. The quality is Better than before and it was super nice before. This will be terribly expensive to catch up on, but I feel it's worth it. I much appreciate the patience and support of my customers through this trying period. Also, many of the items that I should have had and never got made are on the list and I've been assured that they will be made. Even 300F grill bars! And maybe even the center! Also finally the 300F & G side medallion bezel. Let's hope. I'll know soon. As a reminder - I always have 300C through G side medallions in stock. They are injection molded of the finest plastic. Finished beautifully and drilled for the chrome numbers and letters. I also have the letters in stock and the 300 numbers will be in stock again soon. Enjoy the new stuff and thanks!!

Decals !

Excellent reproductions, clear printing, neatly cut edges. Many not found elsewhere (until they copy these!) See pages 37 & 38 in catalog for more. Most decals are shown smaller than actual size.

Replacement for stamped printing on coils. These are printed on clear stock as an easy way to have your coil look original without all the mess and expense of trying to ink stamp it. According to the parts books #570 is for '56-'58, #571 is for '59-'63, and #572 is for '64 and up. Many of the #570 versions have been seen on cars later than '58, so you be the judge of which you want. Doesn't seem to be any distinct cutoff dates.

'55-'59 Jack Instruction Sheets

I am currently working up jack sheets for '55-'59 Imperial, '57-'59 Plymouth, '57-'59 Dodge, '55-'56 Chrysler, and '55 DeSoto. Most are done or nearly completed. The rest will be done by the end of May, '04. Other sheets in this era have been available for 20 years on Page 17 in my catalog. The new ones mentioned will be done on manilla card stock as was original for these years. They are glued on with contact cement. It's time to be perfectly clear on the jack sheets for '55-'59 since there is some confusion and even history rewriting going on. I have never seen, or met anyone who has seen a jack sheet for these years except for DeSoto! 25 years ago when cars of this era were fairly plentiful in Los Angeles wrecking yards, I scrounged for parts and jack sheets. I found lots of DeSoto sheets in DeSotos and lots of DeSoto sheets in Chryslers, but never a Chrysler sheet in a Chrysler or never any sheet at all in Dodge or Plymouth. '56-'59 Chrysler sheets have been around for over 20 years because I changed original DeSoto sheets to show Chryslers in the drawings. Anyone else offering these sheets copied my artwork. So, having made that clear, the above listed sheets will be done the same way. They will look like they would have if there really were original ones. Actual jack placement in the trunk may not be shown 100% accurate. With the exception of Imperials, they will all show the jack placement as seen on the original '55-'59 DeSoto sheets. Nonetheless, a real nice finishing touch on your trunk interior detail. I haven't numbered these sheets yet, so order by description. Cost is \$4 each.

BAT 12V DIST USE WITH EXTERNAL RESISTOR
PART NO 1688212
AUTO-LITE CAH-4001

#570 - \$4.00

BAT 12 V DIST USE WITH EXTERNAL RESISTOR
2444242
CH-412
2495531

#572 - \$4.00

BAT 12V DIST USE WITH EXTERNAL RESISTOR
PART NO. 2095223
ESSEX 67-160-2
MADE IN USA.

#571 - \$4.00

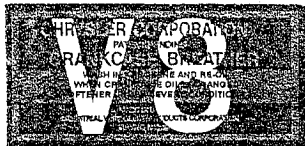

#576 - '56 and earlier crankcase breather (oil filler tube) cap..... \$4.00

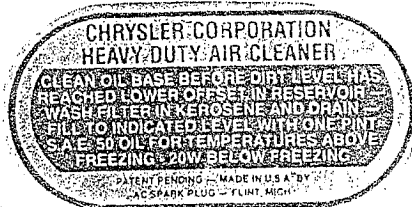

#573 - Large oil bath air cleaner decal used on almost everything from '37-'54 \$4.50

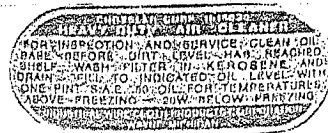

#574 - Small oil bath air cleaner decal used on '55-'56, but not the "bat wing" units..... \$4.00

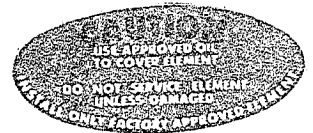

#575 - '56 and earlier power steering pump reservoir..... \$3.00

**CRANKCASE
CAPACITY - 4QTS.**

#577 - '56 and earlier (maybe a year, or two later) oil filler cap (this was taken off an original '56 DeSoto) \$4.00

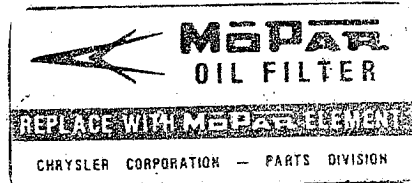

#582 - '57-'58 oil filter canister.... \$3.00

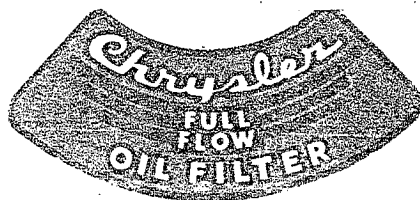

#581 - '55-'56 oil filter canister..... \$3.00

FOR CARS WITH HEATERS:
**OPEN COWL VENT
FOR FRESH AIR HEAT**
SEE INSTRUCTION BOOK
FOR FURTHER INFORMATION:

#580 - '55-'56 attached to inside of glove box door... \$3.50

**USE ONLY
VENTED
GAS CAP**

#579 - '55-'56 gas door. \$3.50

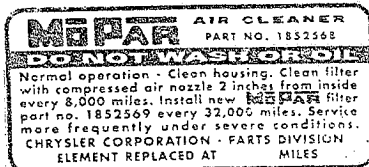

#584 - '62 dual carb air cleaners-slightly different wording than #224, but same size..... \$2.00



#583 - '59 Plymouth air cleaner.....\$6.00



#592 - Decal for Imperial trunk lid handle. '57-'59 (see CHR76, page 47 for new handle) larger than actual size ... \$4.00

THE SPECIAL TIRE EQUIPMENT ON YOUR CAR

Your car has been equipped with four Goodyear Captive-Air safety tires. Because you have this special equipment, there is no requirement for a spare tire. Service instructions and the guarantee covering these tires has been placed in the glove box of your car. You may consult this literature or your dealer for further information.

#586 - Sticker found on a '60 Chrysler driver's door opening (by latch plate) for Captive air tires..... 3 3/4" x 3 3/4" \$7.00
These tires were commonly used on top line 9 passenger Station Wagons in '59 and a few later years and probably earlier. If your '57-'58 wagon doesn't have a provision for a spare, that's the clue - it had captive-air tires.

**CAUTION
BOOSTER OR BATTERY NEG (-) CABLE
MUST GO TO NEG(-) & POS(+) TO
POS (+) DISCONNECT BATTERY
CABLES BEFORE USING CHARGER.**

#585 - '60 and later battery caution label for core support. This one is a little thinner and slightly different Layout than #221\$3.00

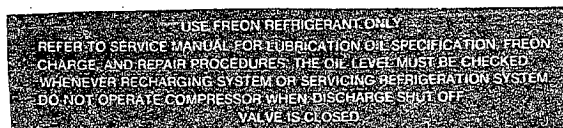

#589 - Red on foil sticker for early A/C compressor (not V type) '55 era \$6.00



#578 - '55 and maybe earlier coil. \$4.00

SUPER RED RAM

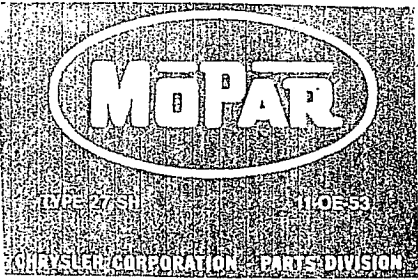

#587A - A sticker for battery to give it a more original look. This one is for the big battery (series 27) for years '56-'58. 6 1/4" x 3 3/4" \$5.00

#587B - Same as above, but for smaller battery (series 24) 6 1/4" x 3 3/4" ... \$5.00

#588A - '59-'62' battery sticker for 27 series 6 1/4" x 3 3/4" \$5.00

#588B - Same as above for 24 series. 6 1/4" x 3 3/4" \$5.00

Note: New cars were not delivered with MoPar batteries! The MoPar stickers were on replacement batteries. Also there doesn't seem to be a consensus as to exactly what years the different stickers were on, so which ever one turns you on basically.

#593 - '55-'57 Dodge hemi valve cover. 11 1/4" long \$18.00 set of 2



#590 - Charger 225 for '63-'64 Dart 6 cyl. air cleaner (see #216) 9 1/4" long \$7.00



#591 - Super 225 for '63-'64 Valiant 6 cyl air cleaner (see 216) ...9 1/4" long \$7.00

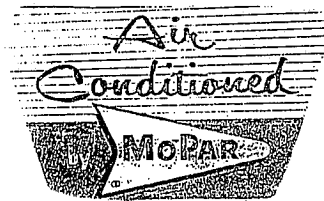
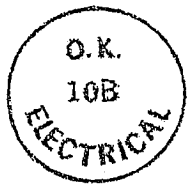
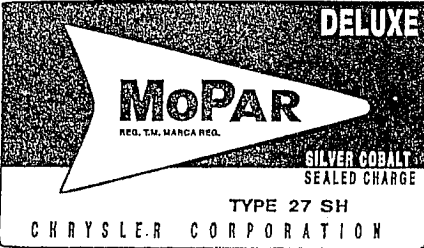

#594 - Rare and unique decal found on top of heater case on car equipped with dealer added MoPar A/C This was a '60, but my guess would be '57-'64 ... 4 1/2" x 3" \$7.00

WIPER - WASH
LIGHTS - PANEL
TUNING
IGNITION
OFF ON VOL

#595 - Black on clear set of stickers to replace painted printing on '60 Chrysler dash aluminum. Scratched and dented originals can be carefully restored with some care pressing out dents and then duplicating the brushed look with 80 grit sandpaper carefully applied in one direction. These individually cut stickers look just like the Original printed words once firmly applied. It will be a little tricky getting them perfectly straight so I'm sending two sets with each order..... \$6.00

#599 - At last! No more pain in the *** ink stamps to mess with. These yellow on clear stickers replace those original ink inspection stamps. They look great on black, so no problem On other colors. Cut right to the border for clean appearance. \$9.00 set of 3



#596 - Another rare and unique sticker. Black on silver sticker goes on convertible windshield header (top) trim..... \$5.00



#597 - '59-'62 Imperial valve cover sticker \$18.00 set



#598 - '63-'66 Imperial valve cover sticker \$14.00 set
Note: Not totally certain on the cutoff year on #597 or the starting year on #598. I'm sure you Imperial nuts know! These are real nice crisp quality, not like some others I've seen.

More new stuff and updates

'58, '61-'63 wheel cover center domes--\$75 each. Beautiful reproductions; made with studs installed to ease assembly.

'57 300 and Imperial wheel cover dome "ears"--\$17 each

'55-'56 visor bracket set--\$220 complete 8 piece set.

'60-'61 swivel seat release handles are finally in stock--\$32

'60-'61 300 side medallion bezels are now in stock--\$110 each

'60 300F grill bars!!! \$300/set

'57-'61 300 side medallions-injection molded plastic in steel dies, not poured urethane always in stock--\$60 each

'57-'61 side medallion numbers and letters always in stock--\$68 per side; complete set.

One piece windshield and back glass seals with molded corners!! Now in stock '57-'59 two door hardtop big glass;

'50-'62 two door hardtop rear glass--\$185 each. Windshield seals for all '57-'64 big cars except Imperial will be here soon.

New washer bag caps are here now--\$12

Coming soon----'55-'56 300. Windsor front and rear glass seals with molded corners:

All washer bags!! If it had a washer bag, I will have the right bag for it very soon.

Washer check valves will be available around end of 2005 (those strange looking plastic things with the tiny bottle cap).

Aproximately \$25

'60-'64 Chrysler two door hardtop and convert. sill plates. About \$400/set. Should be here soon.

Will also fit big

Plymouth and Dodge.

'55-'56 Chrysler two door sill plates are next to be made. Will probably be early 2006

'57-'59 all except Imperial two door hardtop roof rail weatherstrip sets. These are finally going to be made in one

piece and flocked as original. Estimated price around \$200/set. Before end of 2005

